

Dell PowerEdge R760

Technical Guide

Notes, cautions, and warnings

 **NOTE:** A NOTE indicates important information that helps you make better use of your product.

 **CAUTION:** A CAUTION indicates either potential damage to hardware or loss of data and tells you how to avoid the problem.

 **WARNING:** A WARNING indicates a potential for property damage, personal injury, or death.

Chapter 1: System overview.....	5
Key workloads.....	5
New technologies.....	5
Chapter 2: System features and generational comparison.....	7
Chapter 3: Chassis views and features.....	10
Front view of the system.....	10
Rear view of the system.....	11
Inside the system.....	12
Quick Resource Locator.....	14
Chapter 4: Processor.....	16
Processor features	16
Supported processors.....	16
Chapter 5: Memory subsystem.....	17
Supported memory.....	17
Chapter 6: Storage.....	18
Storage controllers.....	18
Supported Drives.....	18
Internal storage configuration.....	19
External Storage.....	19
Chapter 7: Networking.....	21
Overview.....	21
OCP 3.0 support.....	21
Supported OCP cards.....	21
OCP NIC 3.0 vs. rack Network Daughter Card comparisons.....	22
Chapter 8: PCIe subsystem.....	23
PCIe risers.....	23
Chapter 9: Power, thermal, and acoustics.....	33
Power.....	33
Power Supply Units.....	34
Thermal.....	35
Thermal design.....	35
Acoustics.....	36
Acoustical configurations of R760	36
PowerEdge acoustical specifications.....	38

Chapter 10: Rack, rails, and cable management.....	46
Rails and cable management information.....	46
Chapter 11: Operating Systems and Virtualization.....	55
Supported Operating Systems.....	55
Chapter 12: Dell OpenManage Systems Management.....	56
Integrated Dell Remote Access Controller (iDRAC).....	56
Systems Management software support matrix.....	57
Chapter 13: Appendix D: Service and support.....	59
Default support levels.....	59
Default deployment levels.....	59
Other services and support information.....	59
Dell deployment services.....	59
Dell custom deployment Services.....	63
Dell Residency Services.....	63
Dell Data Migration Services.....	63
Dell Enterprise Support Services.....	64
Enterprise connectivity.....	66
Dell TechDirect.....	67
Dell Technologies Consulting Services.....	67
Chapter 14: Appendix A: Additional specifications.....	69
Chassis dimension.....	69
Chassis weight.....	70
NIC port specifications.....	70
Video specifications.....	70
USB Ports.....	71
PSU rating.....	72
Environmental specifications.....	73
Thermal restriction matrix.....	75
Thermal air restrictions.....	81
Chapter 15: Appendix B. Standards compliance.....	83
Chapter 16: Appendix C Additional resources.....	84

System overview

The Dell PowerEdge R760 is Dell's latest two-socket, rack server that is designed to run complex workloads using highly scalable memory, I/O, and network options.

The system features:

- Up to 2 x 4th Gen Intel® Xeon® Scalable Processors with up to 56 cores
- Optional Direct Liquid Cooling for required CPU SKU and/or configurations
- 32 DDR5 DIMM slots
- Two redundant AC or DC power supply units
- Up to 12 x 3.5-inch SAS/SATA, or 24 x 2.5-inch, 16 x 2.5-inch, 8 x 2.5-inch, or 2 x 2.5-inch(rear), 4 x 2.5-inch(rear) SAS, SATA, or NVMe (HDD/SSD) drives
- PCI Express® (PCIe) 5.0 enabled expansion slots
- Network interface technologies to cover Network Interface Card (NIC)

Topics:

- [Key workloads](#)
- [New technologies](#)

Key workloads

The Dell PowerEdge R760 offers powerful performance in a purpose-built, cyber resilient, mainstream server. Ideal for:

- Mixed Workload Standardization
- Database and Analytics
- Virtual Desktop Infrastructure
- Artificial Intelligence and Machine Learning

New technologies

Table 1. New technologies

Technology	Detailed Description
4 th Gen Intel® Xeon® Scalable Processors	Core count: Up to 56 core processor
	UPI speed: Up to 4 links per CPU, speed: 12.8 GT/s, 14.4 GT/s, 16 GT/s
	Maximum number of PCIe lanes per CPU: Integrated 80 PCIe 5.0 lanes @ 32GT/s PCIe Gen5
	Maximum TDP: 350 W
4800 MT/s DDR5 Memory	Max 16 DIMM per processor and 32 DIMMs per system
	Supports DDR5 ECC RDIMM
Flex I/O	Optional LOM board, 2x1Gb with BCM5720 LAN controller
	Rear I/O with: <ul style="list-style-type: none"> • 1x Dedicated iDRAC Ethernet port • 1 x USB 3.0 • 1 x USB 2.0 • 1 x VGA port (optional for Direct Liquid Cooling configuration)

Table 1. New technologies (continued)

Technology	Detailed Description
	Serial Port Option with STD RIO board
	Optional OCP Mezz 3.0 (supported by x8 PCIe lanes)
	Front I/O with: <ul style="list-style-type: none"> ● 1 x USB 2.0 ● 1x iDRAC Direct (Micro-AB USB) port ● 1 x VGA port
CPLD 1-wire	Support payload data of Front PERC, Riser, BP and Rear IO to BOSS-N1 and iDRAC
Dedicated PERC	Front Storage module PERC with Front PERC11 & PERC12
Software RAID	OS RAID / S160
Power Supplies	60 mm dimension is the new PSU form factor on 15G design
	Titanium 700 W AC/HVDC
	Platinum 800 W AC/HVDC
	Titanium 1100 W AC/HVDC
	Platinum 1400 W AC/HVDC
	1100 W -48 LVDC
	Titanium 1800 W AC/HVDC
	86 mm dimension PSU
	Platinum 2400 W AC/HVDC
	Titanium 2800 W AC/HVDC

System features and generational comparison

The following table shows the comparison between the PowerEdge R760 with the PowerEdge R750.

Table 2. Features comparison

Features	PowerEdge R760	PowerEdge R750
Processors	2 x 4 th Gen Intel® Xeon® Scalable Processors	2 x 3 rd Generation Intel® Xeon® Processor Scalable Family
CPU interconnect	Intel Ultra Path Interconnect (UPI)	Intel Ultra Path Interconnect (UPI)
Memory	<ul style="list-style-type: none"> 32 x DDR5 RDIMM Up to 4800 MT/s (1 DPC) / 4400 MT/s (2 DPC) 	<ul style="list-style-type: none"> 32 x DDR4 RDIMM, LRDIMM 16 x PMem (Intel Optane Persistent Memory 200 Series)
Storage Controllers	<ul style="list-style-type: none"> PERC 11G: H755, H755N, H355 PERC 12G: H965i HBA 11: HBA355i, HBA355e BOSS-N1 Software RAID: S160 	<ul style="list-style-type: none"> PERC 10G: H345, H745, H840 PERC 11G: H755, H755N, H355 HBA 11: HBA355i, HBA355e BOSS-S1 adapter BOSS-S2 Software RAID: S150
Drive Bays	<p>Front bays:</p> <ul style="list-style-type: none"> 3.5 inches, 2.5 inches - 24Gb SAS, 6Gb SATA 2.5 inches - Gen3/4 NVMe <p>Rear bay:</p> <ul style="list-style-type: none"> 2.5 inches - 24Gb SAS, 6Gb SATA, Gen3/4 NVMe 	<p>Front bays:</p> <ul style="list-style-type: none"> 3.5 inches, 2.5 inches - 12Gb SAS, 6Gb SATA 2.5 inches - Gen3/4 NVMe <p>Rear bay:</p> <ul style="list-style-type: none"> 2.5 inches - 12Gb SAS, 6Gb SATA, Gen3/4 NVMe
Power Supplies	<ul style="list-style-type: none"> AC (Platinum): 800 W, 1400 W, 2400 W AC (Titanium): 700 W, 1100 W, 1800 W, 2800 W LVDC @-48VDC Input: 1100 W 	<ul style="list-style-type: none"> AC (Platinum): 800 W, 1400 W, 2400 W AC (Titanium): 700 W, 1100 W LVDC @-48VDC Input: 1100 W
Cooling Options	<ul style="list-style-type: none"> Air Cooling Optional Direct Liquid Cooling (DLC) <p>i NOTE: DLC is a rack solution and requires rack manifolds and a cooling distribution unit (CDU) to operate.</p>	<ul style="list-style-type: none"> Air Cooling Optional Direct Liquid Cooling (DLC) <p>i NOTE: DLC is a rack solution and requires rack manifolds and a cooling distribution unit (CDU) to operate.</p>
Fans	<p>Standard (STD) fans /High performance Silver (HPR) fans/ High performance Gold (VHP) fans</p> <p>Up to six hot swap fans</p>	<p>Standard (STD) fans /High performance Silver (HPR) fans/ High performance Gold (VHP) fans</p> <p>Up to six hot swap fans</p>
Dimension	<p>Height: 86.8 mm (3.41 inches)</p> <p>Width: 482 mm (18.97 inches)</p> <p>Depth: 772.13 mm (30.39 inches) with bezel</p> <p>758.29 mm (29.85 inches) without bezel</p>	<p>Height: 86.8 mm (3.41 inches)</p> <p>Width: 482 mm (18.97 inches)</p> <p>Depth: 772.13 mm (30.39 inches) with bezel</p> <p>758.29 mm (29.85 inches) without bezel</p>

Table 2. Features comparison (continued)

Features	PowerEdge R760	PowerEdge R750
Form Factor	2U rack server	2U rack server
Embedded Management	<ul style="list-style-type: none"> • iDRAC9 • iDRAC Direct • iDRAC RESTful with Redfish • iDRAC Service Manual • Quick Sync 2 wireless module 	<ul style="list-style-type: none"> • iDRAC9 • iDRAC Direct • iDRAC Service Module • Quick Sync 2 wireless module
Bezel	Optional LCD bezel or security bezel	Optional LCD bezel or security bezel
OpenManage Software	<ul style="list-style-type: none"> • CloudIQ for PowerEdge plug in • OpenManage Enterprise • OpenManage Enterprise Integration for VMware vCenter • OpenManage Integration for Microsoft System Center • OpenManage Integration with Windows Admin Center • OpenManage Power Manager plugin • OpenManage Service plugin • OpenManage Update Manager plugin 	<ul style="list-style-type: none"> • OpenManage Enterprise • OpenManage Power Manager plugin • OpenManage SupportAssist plugin • OpenManage Update Manager plugin
Mobility	OpenManage Mobile	OpenManage Mobile
Integrations and Connections	OpenManage Integrations <ul style="list-style-type: none"> • BMC TrueSight • Microsoft System Center • OpenManage Integration with ServiceNow • Red Hat Ansible Modules • Terraform Providers • VMware vCenter and vRealize Operations Manager 	OpenManage Integrations <ul style="list-style-type: none"> • BMC TrueSight • Microsoft System Center • Red Hat Ansible Modules • VMware vCenter <ul style="list-style-type: none"> • IBM Tivoli Netcool/OMNibus • IBM Tivoli Network Manager IP Edition • Micro Focus Operations Manager • Nagios Core • Nagios XI
Security	<ul style="list-style-type: none"> • Cryptographically signed firmware • Secure Boot • Secure Erase • Silicon Root of Trust • System Lockdown (requires iDRAC9 Enterprise or Datacenter) • TPM 2.0 FIPS, CC-TCG certified, TPM 2.0 China NationZ • Secured Component Verification (Hardware integrity check) • Data at Rest Encryption (SEDs with local or external key mgmt) 	<ul style="list-style-type: none"> • Cryptographically signed firmware • Secure Boot • Secure Erase • Silicon Root of Trust • System Lockdown (requires iDRAC9 Enterprise or Datacenter) • TPM 1.2/2.0 FIPS, CC-TCG certified, TPM 2.0 China NationZ
Embedded NIC	2 x 1 GbE LOM (optional)	2 x 1 GbE LOM
Networking Options	OCP x8 (optional) Mezz 3.0  NOTE: The system allows either LOM card or an OCP card or both to be installed in the system.	OCP x8 Mezz 3.0
GPU Options	Up to two double wide 350 W, or six single wide 75 W accelerators	Up to two double wide 300 W, or eight single wide 75 W accelerators
Ports	Front Ports <ul style="list-style-type: none"> • 1 x USB 2.0 • 1 x USB 3.0 Rear Ports <ul style="list-style-type: none"> • 1 x USB 2.0 	Front Ports <ul style="list-style-type: none"> • 1 x USB 2.0 • 1 x USB 3.0 Rear Ports <ul style="list-style-type: none"> • 1 x USB 2.0 • 1 x Dedicated iDRAC Ethernet port

Table 2. Features comparison (continued)

Features	PowerEdge R760	PowerEdge R750
	<ul style="list-style-type: none"> ● 1 x iDRAC Direct (Micro-AB USB) port 	<ul style="list-style-type: none"> ● 1 x Dedicated iDRAC Ethernet port ● 1 x USB 3.0 ● 1 x Serial port (optional) ● 1 x VGA (optional for Direct Liquid Cooling configuration)
	Internal Port: 1 x USB 3.0 (optional)	Internal Port: 1 x USB 3.0 (optional)
PCIe	Up to 8 x PCIe Gen4 or up to 4 x PCIe Gen5 slots	UP to 8 x PCIe Gen4 slots
Operating System and Hypervisors	<ul style="list-style-type: none"> ● Canonical Ubuntu Server LTS ● Microsoft Windows Server with Hyper-V ● Red Hat Enterprise Linux ● SUSE Linux Enterprise Server ● VMware ESXi <p>For specifications and interoperability details, see Dell Enterprise Operating Systems on Servers, Storage, and Networking page at Dell.com/OSsupport.</p>	<ul style="list-style-type: none"> ● Canonical Ubuntu Server LTS ● Citrix Hypervisor ● Windows Server LTSC with Hyper-V ● Red Hat Enterprise Linux ● SUSE Linux Enterprise Server ● VMware ESXi <p>For specifications and interoperability details, see Dell Enterprise Operating Systems on Servers, Storage, and Networking page at Dell.com/OSsupport.</p>

Chassis views and features

Topics:

- Front view of the system
- Rear view of the system
- Inside the system
- Quick Resource Locator

Front view of the system



Figure 1. Front view of 24 x 2.5-inch drive system



Figure 2. Front view of 16 x 2.5-inch drive system

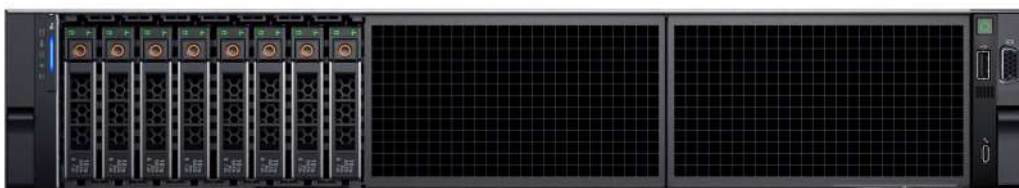

Figure 3. Front view of 8 x 2.5-inch drive system



Figure 4. Front view of 12 x 3.5-inch drive system

Rear view of the system



Figure 5. Rear view of the system



Figure 6. Rear view of the system with optional liquid cooling



Figure 7. Rear view of the system with 2 x 2.5-inch rear drive module



Figure 8. Rear view of the system with 4 x 2.5-inch rear drive module

Inside the system

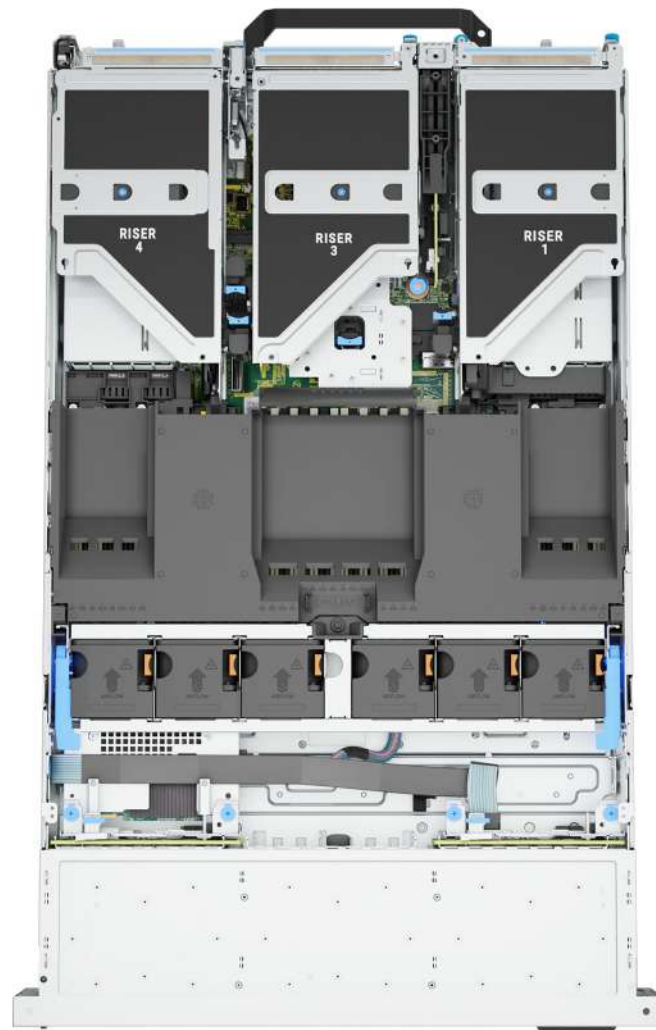

Figure 9. Inside the system

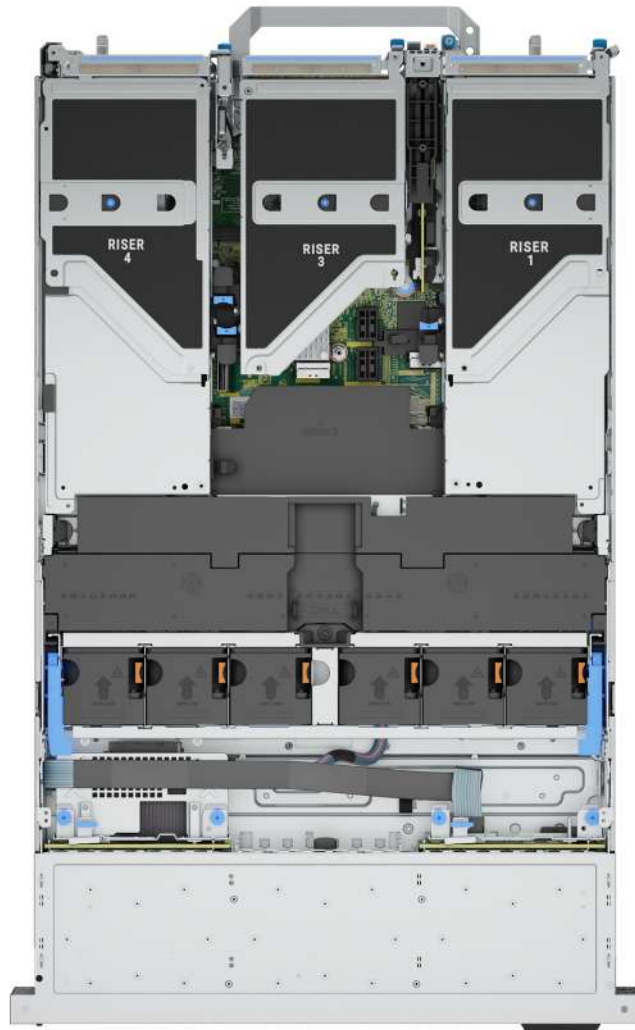

Figure 10. Inside the system with full length risers and GPU shroud



Figure 11. Inside the system with processor liquid cooling module

NOTE: Air shroud is hidden in the above image to show the processor liquid cooling configuration.

Quick Resource Locator

The QRL on everything (SILs, GSG, Owner's Manual except on the EST) is a generic QRL for R760 that leads to a webpage for that product. That webpage has links for things like setup and service videos, iDRAC manual, and other things that apply to the platform. The QRL on the EST is unique and specific to that service tag and will contain the Service Tag number and the iDRAC password. The label and the QRL code within it are printed on demand at the L10 factories. This QRL links to a webpage that shows the exact configuration as built for that customer, and the specific warranty purchased. It is one click away from the same content of generic information that applies to R760 that is available in the other QRLs.



Figure 12. Quick Resource Locator for PowerEdge R760 system

Processor

Topics:

- [Processor features](#)

Processor features

The Intel 4th Generation Xeon® Scalable Processors stack is the next generation data center processor offering with significant performance increases, integrated acceleration, and next generation memory and I/O. Sapphire Rapids accelerate customer usages with unique workload optimizations.

The following lists the features and functions that are in the upcoming 4th Generation Intel® Xeon Scalable Processor offering:

- Faster UPI with up to four Intel Ultra Path Interconnect (Intel UPI) at up to 16 GT/s, increasing multisocket bandwidth
- More, faster I/O with PCI Express 5 and up to 80 lanes (per socket)
- Enhanced Memory Performance with DDR5 support and memory speed up to 4800 MT/s in one DIMM per channel (1DPC) and 4400 MT/s in two DIMM per channel (2DPC)
- New built-in accelerators for data analytics, networking, storage, crypto, and data compression

Supported processors

The following table shows the Intel Sapphire Rapids SKUs that are supported on the R760.

Table 3. Supported Processors for R760

Processor	Clock Speed (GHz)	Cache (M)	UPI (GT/s)	Cores	Threads	Turbo	Memory Speed (MT/s)	Memory Capacity	TDP
8480+	2	105	16	56	112	Turbo	4800	6 TB	350 W
8471N	1.8	98	16	52	104	Turbo	4800	6 TB	300 W
8470Q*	2.1	98	16	52	104	Turbo	4800	6 TB	350 W
8470N	1.7	98	16	52	104	Turbo	4800	6 TB	300 W
8470	2	98	16	52	104	Turbo	4800	6 TB	350 W
8468	2.1	90	16	48	96	Turbo	4800	6 TB	350 W
8460Y+	2	75	16	40	80	Turbo	4800	6 TB	300 W
8452Y	2	68	16	36	72	Turbo	4800	6 TB	300 W
6454S	2.2	60	16	32	64	Turbo	4800	6 TB	270 W
6430	2.1	60	16	32	64	Turbo	4800	6 TB	270 W
6414U	2	60	16	32	64	Turbo	4800	6 TB	250 W

 **NOTE:** *8470Q is supported only in liquid cooling configuration.

Memory subsystem

Topics:

- Supported memory

Supported memory

Table 4. Memory technology comparison

Feature	PowerEdge R760 (DDR5)
DIMM type	RDIMM
Transfer speed	4800 MT/s (1DPC), 4400 MT/s (2DPC)
Voltage	1.1 V

Table 5. Supported memory matrix

DIMM type	Rank	Capacity	DIMM rated voltage and speed	Operating Speed	
				1 DIMM per channel (DPC)	2 DIMMs per channel (DPC)
RDIMM	1 R	16 GB	DDR5 (1.1 V), 4800 MT/s	4800 MT/s	4400 MT/s
	2 R	32 GB, 64 GB	DDR5 (1.1 V), 4800 MT/s	4800 MT/s	4400 MT/s
	4 R	128 GB	DDR5 (1.1 V), 4800 MT/s	4800 MT/s	4400 MT/s
	8 R	256 GB	DDR5 (1.1 V), 4800 MT/s	4800 MT/s	4400 MT/s

 **NOTE:** The processor may reduce the performance of the rated DIMM speed.

Storage

Topics:

- Storage controllers
- Supported Drives
- Internal storage configuration
- External Storage

Storage controllers

Dell RAID controller options offer performance improvements, including the fPERC solution. fPERC provides a base RAID HW controller without consuming a PCIe slot by using a small form factor and high-density connector to the base planar.

16G PERC Controller offerings are a heavy leverage of 15G PERC family. The Value and Value Performance levels carry over to 16G from 15G. New to 16G is the Avenger-based Premium Performance tier offering. This high-end offering drives IOPs performance and enhanced SSD performance.

Table 6. PERC Series controller offerings

Performance Level	Controller and Description
Entry	S160
Value	H355, HBA355 (internal/external)
Value Performance	H755, H755N
Premium Performance	H965i, Avenger 1 Memory: 8GB DDR4 NV cache 72-bit memory 2133 MHz Low profile form factors Dual A15 1.2 GHz CPU X8PCIe 3.0, x8 12Gb SAS

NOTE: For more information about the features of the Dell PowerEdge RAID controllers (PERC), Software RAID controllers, or BOSS card, and on deploying the cards, see the storage controller documentation at www.dell.com/storagecontrollermanuals.

NOTE: From December 2021, H355 replaces H345 as the entry raid controller. H345 is deprecated in January 2022.

Supported Drives

The table shown below lists the internal drives supported by the R760.

Table 7. Supported Drives

Form Factor	Type	Speed	Rotational Speed	Capacities
2.5 inches	vSAS	12 Gb	SSD	1.92 TB, 3.84 TB, 960 GB, 7.62 TB
2.5 inches	SAS	24 Gb	SSD	1.92 TB, 1.6 TB, 800 GB, 3.84 TB, 960 GB, 7.68 TB
2.5 inches	SATA	6 Gb	SSD	1.92 TB, 480 GB, 960 GB, 3.84 TB
2.5 inches	NVMe	Gen4	SSD	1.6 TB, 3.2 TB, 6.4 TB, 1.92 TB, 3.84 TB, 15.63 TB, 7.68 TB, 800 GB, 400 GB
2.5 inches	DC NVMe	Gen4	SSD	3.84 TB, 960 GB
2.5 inches	SAS	12 Gb	10 K	600 GB, 1.2 TB, 2.4 TB
3.5 inches	SATA	6 Gb	7.2 K	2 TB, 4 TB, 8 TB, 12 TB, 16 TB, 20 TB
3.5 inches	SAS	12 Gb	7.2 K	2 TB, 4 TB, 8 TB, 12 TB, 16 TB, 20 TB

Internal storage configuration

R760 available internal storage configurations:

- Zero drives (no backplane)
- 12x3.5" (SAS/SATA)
- 12x3.5" w/ rear 2x2.5" (SAS/SATA)
- 12x3.5" w/ rear 2x2.5" NVMe
- 12x3.5" + 4x2.5" (SAS/SATA)
- 12x3.5" (SAS/SATA) + 4x2.5" (NVMe)
- 8x2.5" NVMe
- 8x2.5" (NVMe RAID)
- 8x2.5" Universal
- 16x2.5" (NVMe RAID)
- 16x2.5" (NVMe)
- 16x2.5" (SAS4/SATA)
- 16x2.5"(SAS4/SATA)+ 8x2.5" NVMe
- 24x2.5" (SAS4/SATA) with 8x Universal slots
- 24x2.5" (SAS4/SATA)
- 24x2.5" (SAS4/SATA) + 2x2.5" (NVMe)
- 24x2.5"(SAS4/SATA) + 2x2.5" (SAS/SATA)
- 24x2.5"(SAS4/SATA) + 4x2.5" (SAS/SATA)
- 24x2.5" (SAS4/SATA) + 4x2.5" (NVMe)
- 24x2.5" (SAS4/SATA) - Dual Controller
- 24x2.5" + 2x2.5" (SAS4/SATA) - Dual Controller
- 24x2.5" (SAS4/SATA) with 8x Universal slots
- 24x2.5" (SAS4/SATA)
- 24x2.5" (SAS4/SATA) - Dual Controller
- 24x2.5" (SAS4/SATA) with 4x Universal slots + 4x2.5" (SAS4/SATA)
- 16x2.5" (8x SAS4/SATA + 8x NVMe RAID)
- 16x2.5" (8x NVMe RAID + 8x SAS4/SATA)
- 24x2.5" (NVMe Gen4) Passive

External Storage

The R760 support the external storage device types listed in the table below.

Table 8. Support External Storage Devices

Device Type	Description
External Tape	Supports connection to external USB tape products
NAS/IDM appliance software	Supports NAS software stack
JBOD	Supports connection to 12 Gb MD-series JBODs

Networking

Topics:

- [Overview](#)
- [OCP 3.0 support](#)

Overview

PowerEdge offers a wide variety of options to get information moving to and from our servers. Industry best technologies are chosen, and systems management features are added by our partners to firmware to tie in with iDRAC. These adapters are rigorously validated for worry-free, fully supported use in Dell servers.

OCP 3.0 support

Table 9. OCP 3.0 feature list

Feature	OCP 3.0
Form factor	SFF
PCIe Gen	Gen4
Max PCIe width	x8
Max no. of ports	4
Port type	BT/SFP/SFP+/SFP28/SFP56
Max port speed	100 GbE
NC-SI	Yes
SNAPI	Yes
WoL	Yes
Power consumption	15 W–150 W

Supported OCP cards

Table 10. Supported OCP cards

Form factor	Vendor	Port type	Port speed	Port count
OCP 3.0	Intel	SFP28	25 GbE	4
	Broadcom	SFP28	25 GbE	4
	Intel	SFP28	25 GbE	2
	Broadcom	SFP28	25 GbE	2
	Broadcom	BT	10 GbE	4
	Intel	BT	10 GbE	2

Table 10. Supported OCP cards (continued)

Form factor	Vendor	Port type	Port speed	Port count
	Intel	BT	10 GbE	4
	Broadcom	BT	1 GbE	4
	Intel	BT	1 GbE	4

OCP NIC 3.0 vs. rack Network Daughter Card comparisons

Table 11. OCP 3.0, 2.0, and rNDC NIC comparison

Form Factor	Dell rNDC	OCP 2.0 (LOM Mezz)	OCP 3.0	Notes
PCIe Gen	Gen 3	Gen 3	Gen 4	Supported OCP3 are SFF (small form factor)
Max PCIe Lanes	x8	Up to x16	Up to x8	See server slot priority matrix
Shared LOM	Yes	Yes	Yes	This is iDRAC port redirect
Aux Power	Yes	Yes	Yes	Used for Shared LOM

PCIe subsystem

Topics:

- PCIe risers

PCIe risers

Shown below are the riser offerings for the platform.

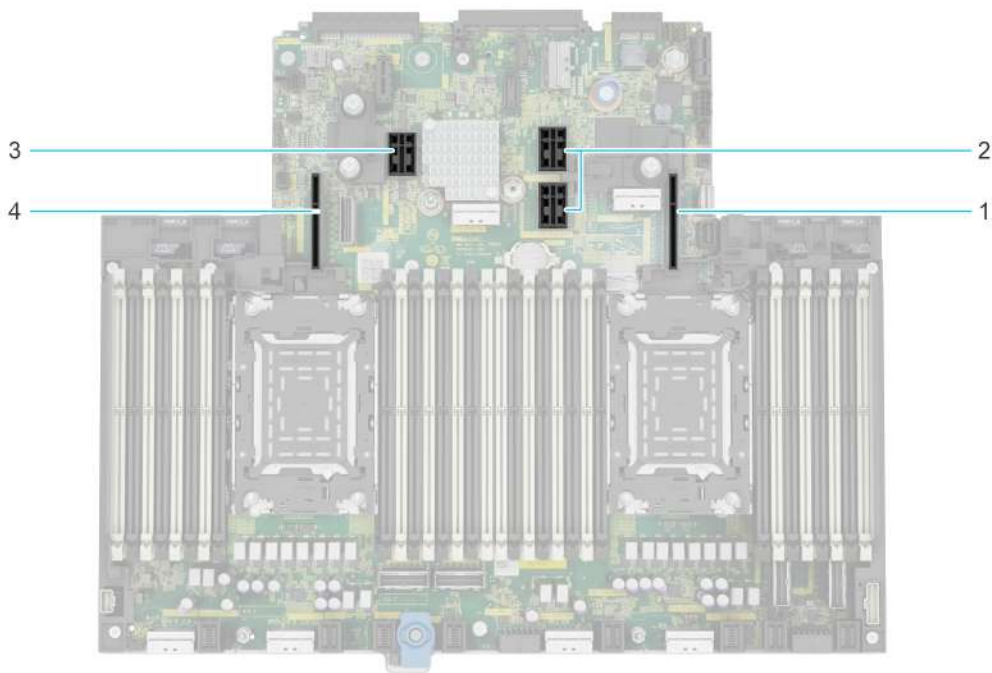

Figure 13. Riser connector location on system board

- | | |
|------------|------------|
| 1. Riser 1 | 2. Riser 2 |
| 3. Riser 3 | 4. Riser 4 |

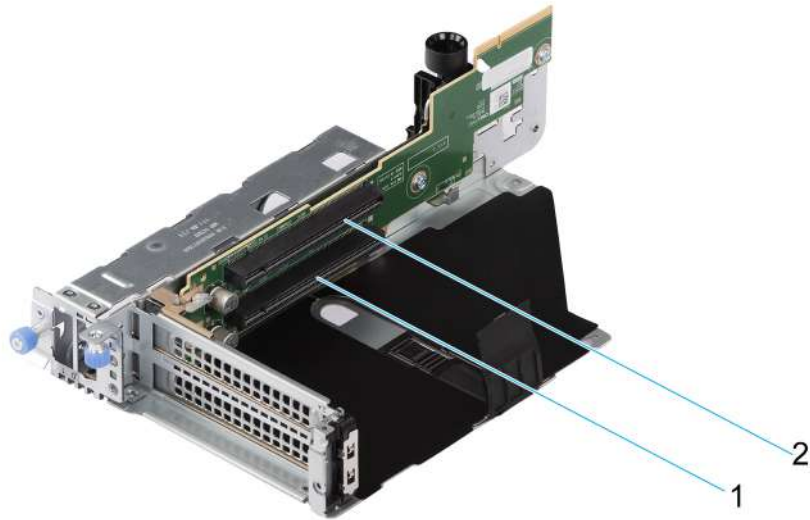

Figure 14. Riser 1B

- 1. Slot 1
- 2. Slot 2

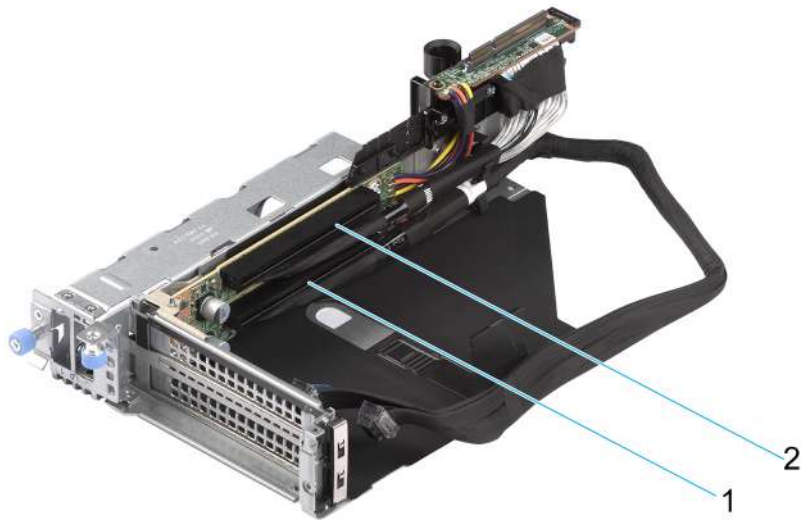

Figure 15. Riser 1R

- 1. Slot 1
- 2. Slot 2

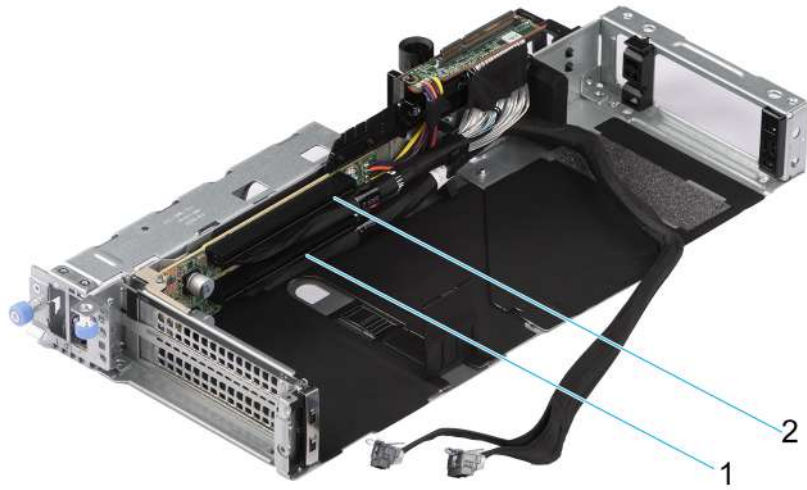

Figure 16. Riser 1R FL

- 1. Slot 1
- 2. Slot 2

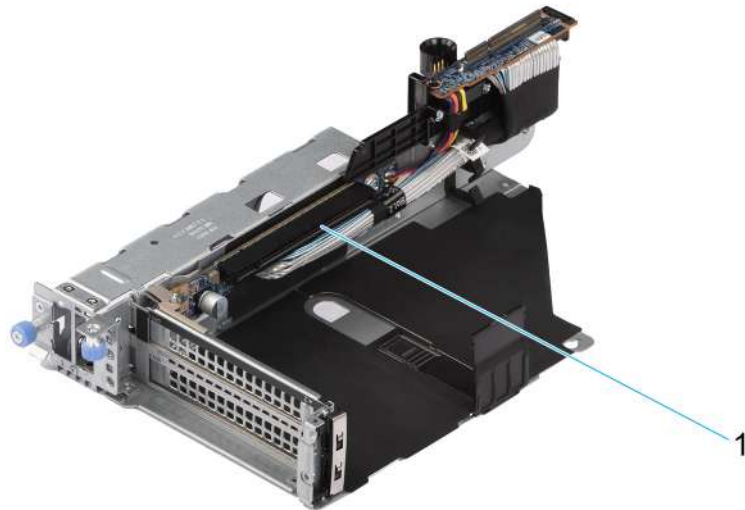

Figure 17. Riser 1P

- 1. Slot 2

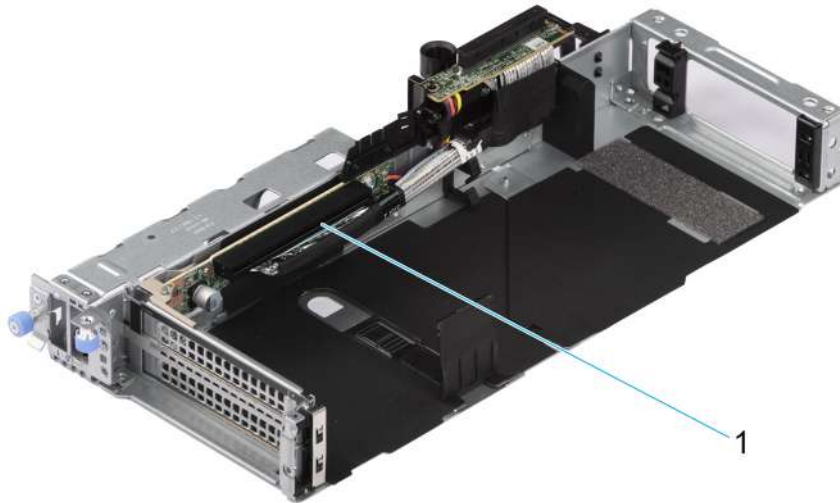

Figure 18. Riser 1P FL

- 1. Slot 2

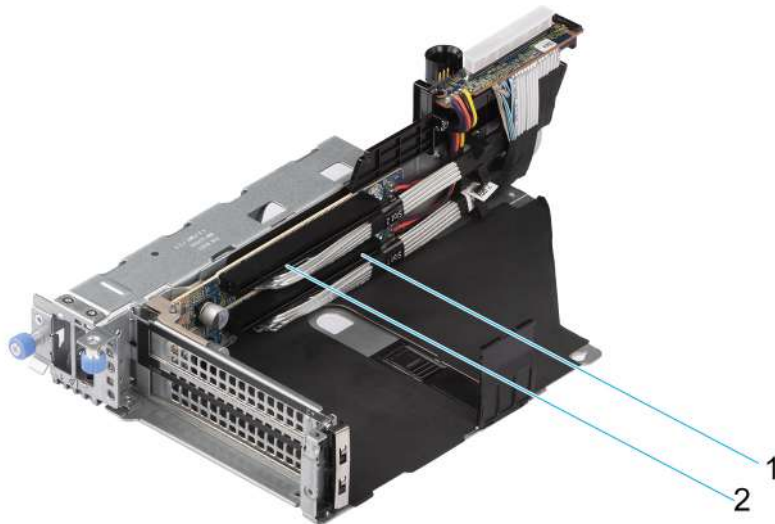

Figure 19. Riser 1Q

- 1. Slot 1
- 2. Slot 2

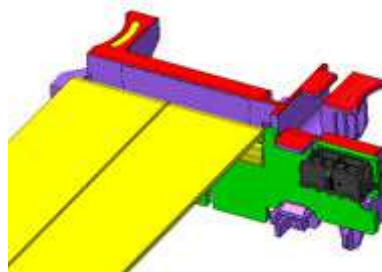

Figure 20. Riser R1 Paddle

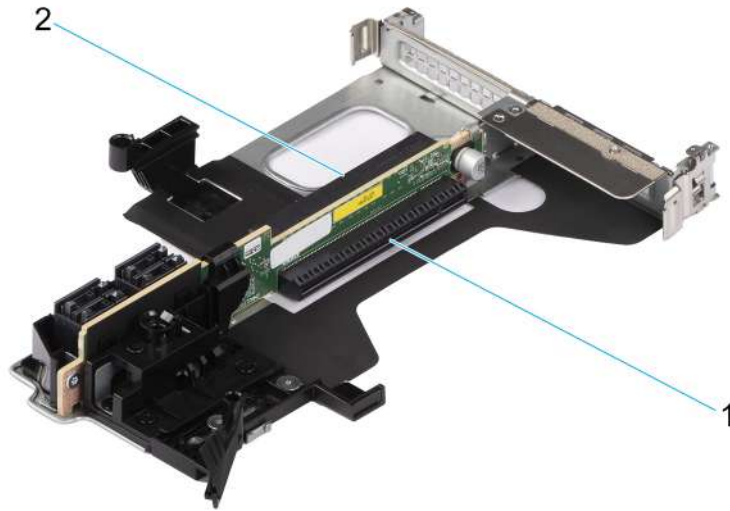

Figure 21. Riser 2A

- 1. Slot 6
- 2. Slot 3

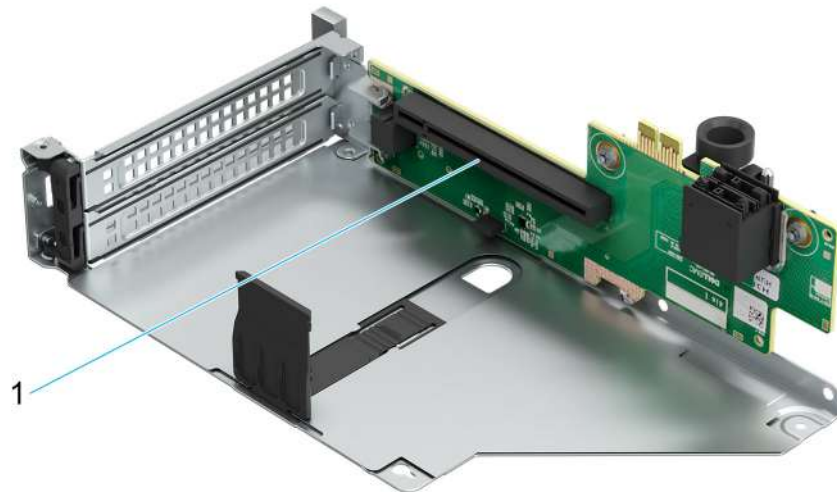

Figure 22. Riser 3A

- 1. Slot 5

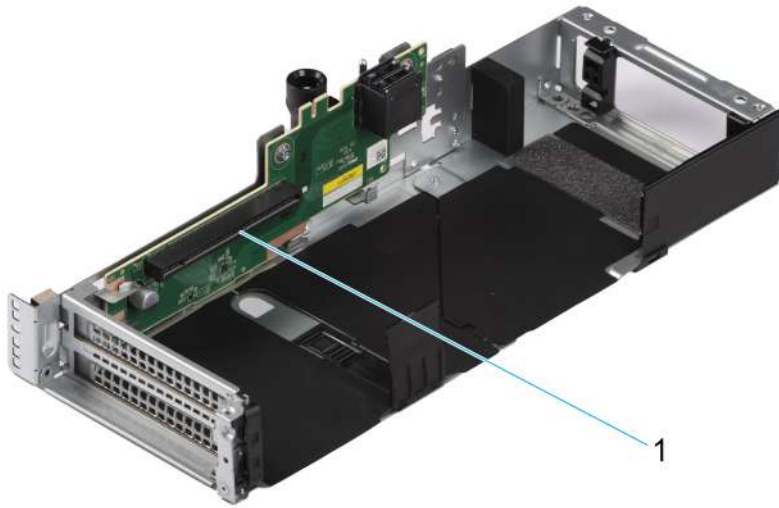

Figure 23. Riser 3A FL

1. Slot 5

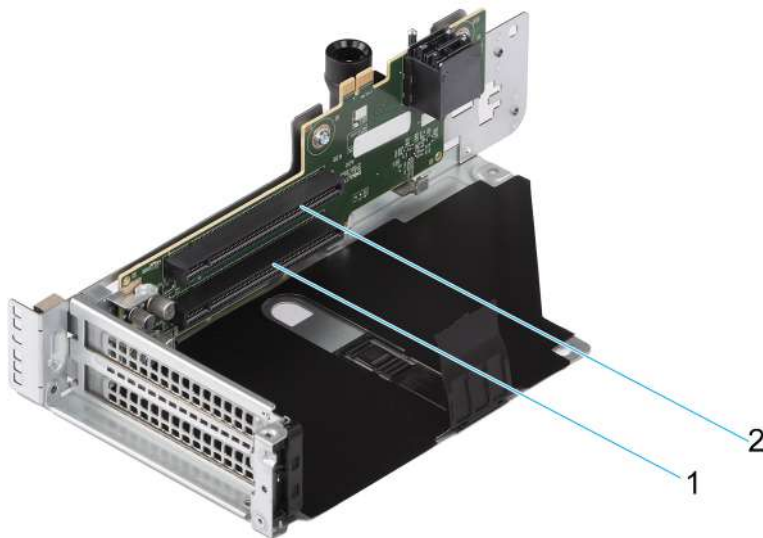

Figure 24. Riser 3B

1. Slot 4
2. Slot 5

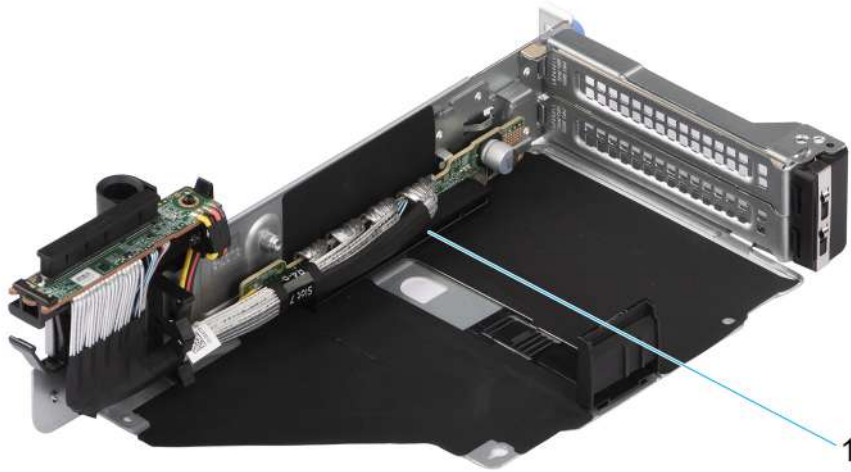

Figure 25. Riser 4P

1. Slot 7

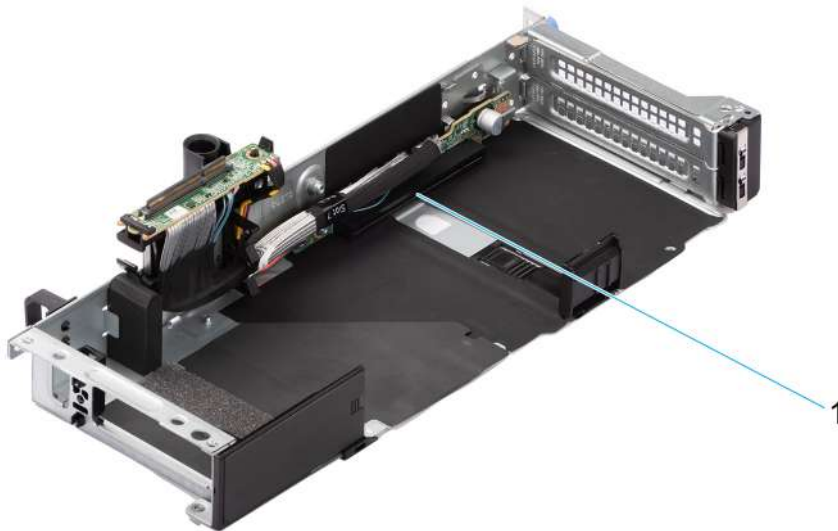

Figure 26. Riser 4P - FL

1. Slot 7

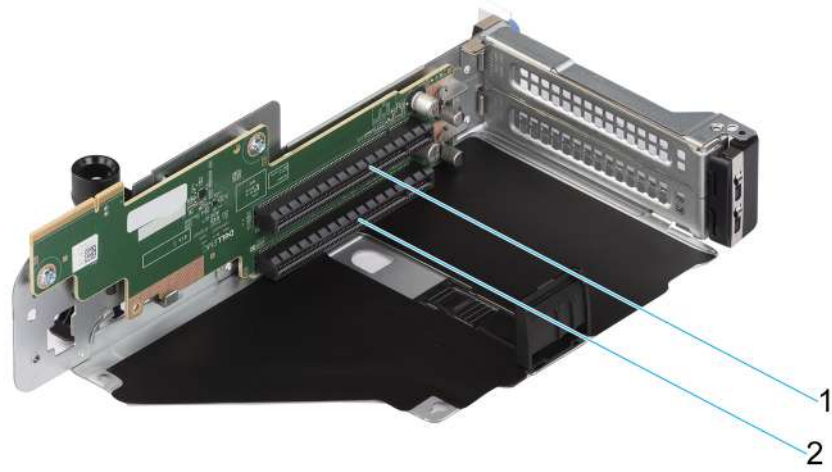

Figure 27. Riser 4B

1. Slot 8
2. Slot 7

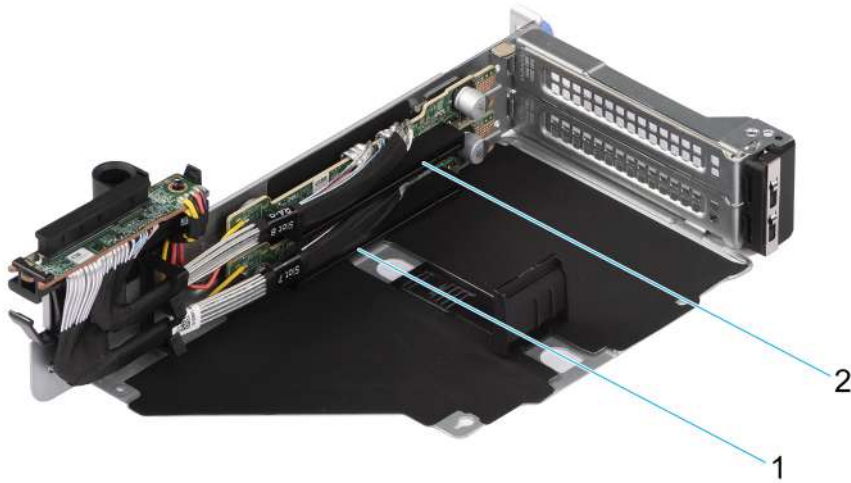

Figure 28. Riser 4Q

1. Slot 7
2. Slot 8

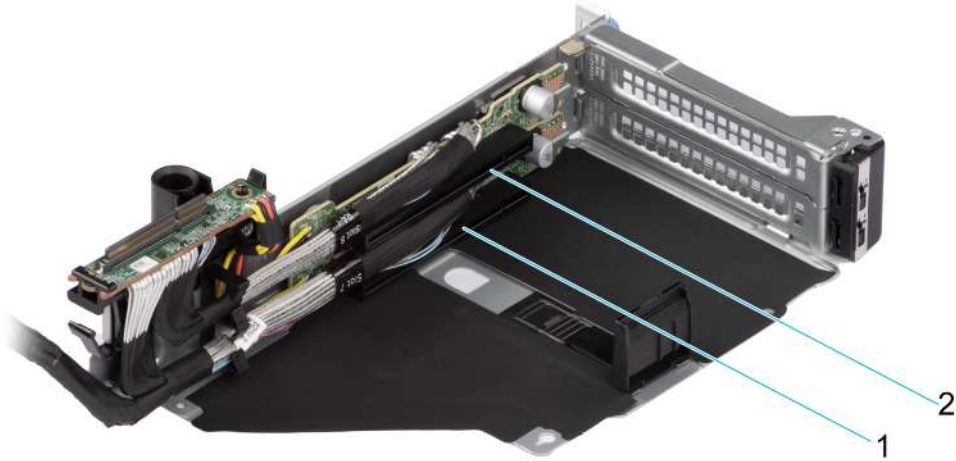

Figure 29. Riser 4R

- 1. Slot 7
- 2. Slot 8

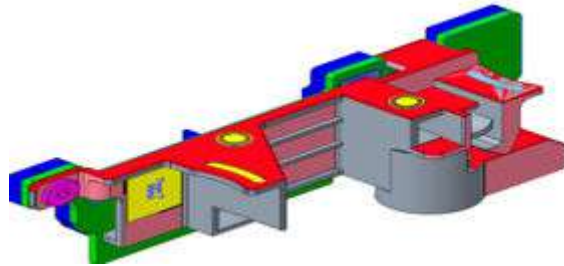

Figure 30. Riser R4 Paddle

Table 12. PCIe Riser Configurations

Config No.	Riser configuration	No. of Processors	PERC type supported	Rear storage possible
0	NO RSR	2	Front PERC	No
1	R1B+R2A+R3B+R4B	2	Front PERC/PERC Adapter	No
2	R1Q+R2A+R3B+R4Q	2	Front PERC/PERC Adapter	No
3-1	R1P+R2A+R3B+R4P (HL)	2	Front PERC/PERC Adapter	No
3-2	R1P+R2A+R3B+R4P (FL)	2	Front PERC/PERC Adapter	No
4-1	R1P+R2A+R3B+R4R (HL)	2	Front PERC/PERC Adapter	No
5-1	R1R+R2A+R3A+R4P (HL)	2	Front PERC/PERC Adapter	No
5-2	R1R+R2A+R3A+R4P (FL)	2	Front PERC/PERC Adapter	No
6	R2A+R4Q	2	Front PERC/PERC Adapter	Yes

Table 12. PCIe Riser Configurations (continued)

Config No.	Riser configuration	No. of Processors	PERC type supported	Rear storage possible
7	R1Q+R2A+R4Q	2	Front PERC/PERC Adapter	Yes
8	R1B+R2A	1	PERC Adapter	No
9	R1Q+R2A+R4R	1	Front PERC	No
10-1	R1P+R2A+R4R (HL)	1	Front PERC	No
10-2	R1P+R2A+R4R (FL)	1	Front PERC	No
11	R1 Paddle + R2A + R3B + R4 Paddle	2	N/A	No
12	R1Q+R2A+R4Q	2	Front PERC/PERC Adapter	Yes

Power, thermal, and acoustics

PowerEdge servers have an extensive collection of sensors that automatically track thermal activity, which helps to regulate temperature by reducing server noise and power consumption. The table below lists the tools and technologies Dell offers to lower power consumption and increase energy efficiency.

Topics:

- [Power](#)
- [Thermal](#)
- [Acoustics](#)

Power

Table 13. Power tools and technologies

Feature	Description
Power Supply Units(PSU) portfolio	Dell's PSU portfolio includes intelligent features such as dynamically optimizing efficiency while maintaining availability and redundancy. Find additional information in the Power supply units section.
Tools for right sizing	Enterprise Infrastructure Planning Tool (EIPT) is a tool that can help you determine the most efficient configuration possible. With Dell's EIPT, you can calculate the power consumption of your hardware, power infrastructure, and storage at a given workload. Learn more at www.dell.com/calc .
Industry Compliance	Dell's servers are compliant with all relevant industry certifications and guide lines, including 80 PLUS, Climate Savers and ENERGY STAR.
Power monitoring accuracy	PSU power monitoring improvements include: <ul style="list-style-type: none"> • Dell's power monitoring accuracy is currently 1%, whereas the industry standard is 5% • More accurate reporting of power • Better performance under a power cap
Power capping	Use Dell's systems management to set the power cap limit for your systems to limit the output of a PSU and reduce system power consumption. Dell is the first hardware vendor to leverage Intel Node Manager for circuit-breaker fast capping.
Systems Management	iDRAC Enterprise and Datacenter provides server-level management that monitors, reports and controls power consumption at the processor, memory and system level. Dell OpenManage Power Center delivers group power management at the rack, row, and data center level for servers, power distribution units, and uninterruptible power supplies.
Active power management	Intel Node Manager is an embedded technology that provides individual server-level power reporting and power limiting functionality. Dell offers a complete power management solution comprised of Intel Node Manager accessed through Dell iDRAC9 Datacenter and OpenManage Power Center that allows policy-based management of power and thermal at the individual server, rack, and data center level. Hot spare reduces power consumption of redundant power supplies. Thermal control off a speed optimizes the thermal settings for your environment to reduce fan consumption and lower system power consumption. Idle power enables Dell servers to run as efficiently when idle as when at full workload.
Rack infrastructure	Dell offers some of the industry's highest-efficiency power infrastructure solutions, including:

Table 13. Power tools and technologies (continued)

Feature	Description
	<ul style="list-style-type: none"> • Power distribution units (PDUs) • Uninterruptible power supplies (UPSs) • Energy Smart containment rack enclosures Find additional information at: https://www.delltechnologies.com/en-us/servers/power-and-cooling.htm .

Power Supply Units

Energy Smart power supplies have intelligent features, such as the ability to dynamically optimize efficiency while maintaining availability and redundancy. Also featured are enhanced power-consumption reduction technologies, such as high-efficiency power conversion and advanced thermal-management techniques, and embedded power-management features, including high-accuracy power monitoring. The table below shows the power supply unit options that are available for the R760.

Table 14. Power Supply Unit Options

Wattage	Frequency	Voltage/Current	Class	Heat dissipation
700 W mixed mode	50/60 Hz	200–240 Vac/4.1 A	Titanium	2625 BTU/hr
	N/A	240 Vdc/3.4 A	N/A	2625 BTU/hr
800 W mixed mode	50/60 Hz	100–240 Vac/9.2—4.7 A	Platinum	3000 BTU/hr
	N/A	240 Vdc/3.8 A	N/A	3000 BTU/hr
1100 W mixed mode	50/60 Hz	100–240 Vac/12—3.6 A	Titanium	4100 BTU/hr
	N/A	240 Vdc/5.2 A	N/A	4100 BTU/hr
1100 W -48 LVDC	N/A	-48—-60 Vdc/ 27 A	N/A	4625 BTU/hr
1400 W mixed mode	50/60 Hz	100–240 Vac/12—8 A	Platinum	5250 BTU/hr
	N/A	240 Vdc/6.6 A	N/A	5250 BTU/hr
1800 W mixed mode	50/60 Hz	200–240 Vac/10 A	Titanium	6750 BTU/hr
	N/A	240 Vdc/8.2 A	N/A	6750 BTU/hr
2400 W mixed mode	50/60 Hz	100–240 Vac/ 16—13.5 A	Platinum	9000 BTU/hr
	N/A	240 Vdc/11.2 A	N/A	9000 BTU/hr
2800 W mixed mode	50/60 Hz	200–240 Vac/15.6 A	Titanium	10,500 BTU/hr
	N/A	240 Vdc/13.6 A	N/A	10,500 BTU/hr

NOTE: If a system with AC 2400 W PSUs operates at low line 100-120 Vac, and then the power rating per PSU is degraded to 1400 W.

NOTE: If a system with AC 1400 W or 1100 W PSUs operates at low line 100-120 Vac, and then the power rating per PSU is degraded to 1050 W.



Figure 31. PSU power cords

Table 15. PSU power cords

Form factor	Output	Power cord
Redundant 60 mm	700 W AC	C13
	800 W AC	C13
	1100 W AC	C13
	1100 W -48 LVDC	C13
	1400 W AC	C13
	1800 W AC	C15
Redundant 86 mm	2400 W AC	C19
	2800 W AC	C21

NOTE: C19 power cord combined with C20 to C21 jumper power cord can be used to adapt 2800 W PSU.

NOTE: C13 power cord combined with C14 to C15 jumper power cord can be used to adapt 1800 W PSU.

Thermal

PowerEdge servers have an extensive collection of sensors that automatically track thermal activity, which helps regulate temperature thereby reducing server noise and power consumption.

Thermal design

Thermal management of the platform helps deliver high performance with the right amount of cooling to components, while maintaining the lowest fan speeds possible. This is done across a wide range of ambient temperatures from 10°C to 35°C (50°F to 95°F) and to extended ambient temperature ranges.

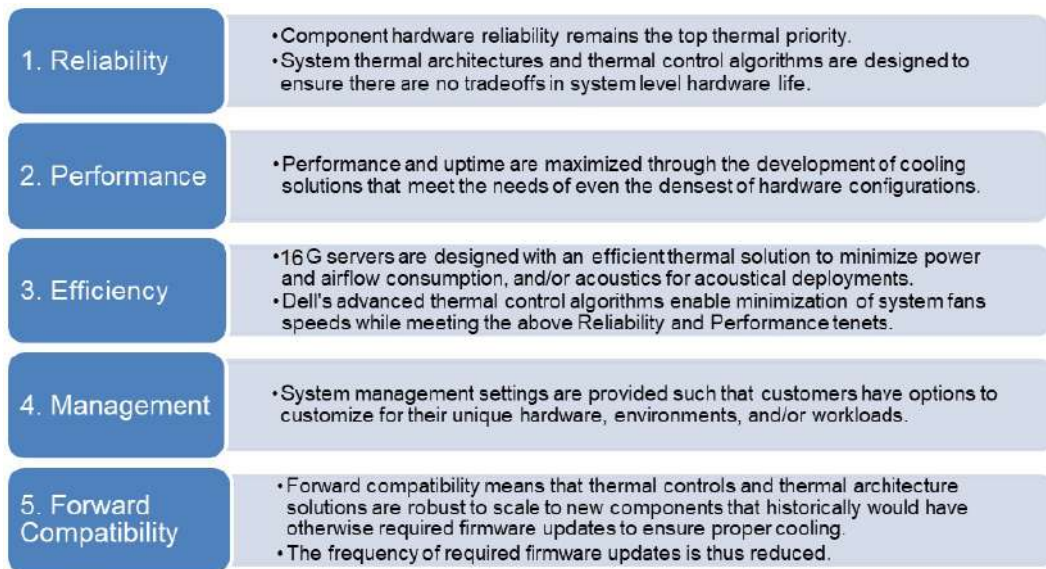

Figure 32. Thermal design characteristics

The thermal design of the PowerEdge R760 reflects the following:

- Optimized thermal design: The system layout is architected for optimum thermal design.
- System component placement and layout are designed to provide maximum airflow coverage to critical components with minimum expense of fan power.

- Comprehensive thermal management: The thermal control system regulates the fan speed based on several different responses from all system-component temperature sensors, and inventory for system configurations. Temperature monitoring includes components such as processors, DIMMs, chipset, the inlet air ambient, hard disk drives, and OCP.
- Open and closed loop thermal fan speed control: Open loop thermal control uses system configuration to determine fan speed based on inlet air ambient temperature. Closed loop thermal control method uses feedback temperatures to dynamically determine proper fan speeds.
- User-configurable settings: With the understanding and realization that every customer has unique set of circumstances or expectations from the system, in this generation of servers, we have introduced limited user- configurable settings residing in the iDRAC BIOS setup screen. For more information, see the Dell PowerEdge R760 Installation and Service Manual at www.dell.com/poweredgemanuals and “Advanced Thermal Control: Optimizing across Environments and Power Goals” on Dell.com.
- Cooling redundancy: The R760 allows N+1 fan redundancy, allowing continuous operation with one fan failure in the system.
- Environmental Specifications: The optimized thermal management makes the R760 reliable under a wide range of operating environments.

Acoustics

Acoustical configurations of R760

Dell PowerEdge R760 is a rack or tower server appropriate for attended data center environment. However, lower acoustical output is attainable with proper hardware or software configurations.

Table 16. Configurations tested for acoustical experience

Configuration	Quietest GPU configuration	Entry/ Quietest configuration	Typical-1, 2.5-inch	Typical-2, 3.5-inch	GPU configuration	NVMe Box
CPU TDP	125 W	125 W	150 W	150 W	165 W	270 W
CPU Quantity	2	2	2	2	2	2
RDIMM Memory	16 GB DDR5	16 GB DDR5	16 GB DDR5	32 GB DDR5	32 GB DDR5	16 GB DDR5
Memory Quantity	8	8	8	16	32	32
Backplane Type	8 x 2.5-inch BP	12x 3.5-inch BP	16 x 2.5-inch exp BP	12 x 3.5-inch BP + 2 x 2.5-inch rear BP	16 x 2.5-inch exp BP	24 x 2.5-inch exp BP (NVMe)
HDD Type	X	SATA 3.5-inch 4 TB	X	12 x 3.5-inch front 12 TB, 2 x 2.5-inch rear SSD	X	X
HDD Quantity	X	2	X	12 + 2	X	X
Flash Drives	PCIe SSD	X	PCIe SSD	X	PCIe SSD	PCIe SSD
Flash Quantity	8	X	8	X	16	24
PSU Type	1400 W	800 W	800 W	1400 W	2400 W	2400 W
PSU Quantity	2	2	2	2	2	2
OCP	2x10 G	2x10 G	10/25 2-port	10/25 2-port	10/25 2-port	2x25 G
PCI 1	X	X	X	X	X	X
PCI 2	X	X	X	X	GPU	100 Gb PCI
PCI 3	X	H755	X	H755	X	X
PCI 4	X	X	2-port 25 Gb	1-port 10 Gb	2-port 25 Gb	X

Table 16. Configurations tested for acoustical experience (continued)

Configuration	Quietest GPU configuration	Entry/ Quietest configuration	Typical-1, 2.5-inch	Typical-2, 3.5-inch	GPU configuration	NVMe Box
PCI 5	X	X	2-port 25 Gb	1-port 10 Gb	2-port 25 Gb	X
PCI 6	X	X	X	Adapt H745	X	X
PCI 7	A30	X	X	X	GPU	100 Gb PCI
PCI 8	X	X	X	X	X	X
PERC	Front H755n	Adapt H755	Front H7455n	Adapt H755	Front H755n	Front H755n

Table 17. Acoustical experience of R760 configurations

Configuration	Quietest GPU configuration	Entry/ Quietest configuration	Typical-1, 2.5-inch	Typical-2, 3.5-inch	GPU configuration	NVMe Box	
Acoustical Performance: Idle/ Operating @ 25°C Ambient							
L _{WA,m} (B)	Idle ⁽⁴⁾	6.8	5.1	5.5	6.4	6.9	6.8
	Operating/ Customer usage operating ⁽⁵⁾⁽⁶⁾	8.1	5.1	5.5	6.4	8.5	6.8
K _v (B)	Idle ⁽⁴⁾	0.4	0.4	0.4	0.4	0.4	0.4
	Operating/ Customer usage operating ⁽⁵⁾⁽⁶⁾	0.4	0.4	0.4	0.4	0.4	0.4
L _{pA,m} (dB)	Idle ⁽⁴⁾	47	32	41	42	48	47
	Operating/ Customer usage operating ⁽⁵⁾⁽⁶⁾	62	32	41	42	67	47
Prominent discrete tones ⁽³⁾		Prominence ratio < 17 dB	No audible tones		Prominence ratio < 15 dB	Prominence ratio < 17 dB	Prominence ratio < 15 dB
Acoustical Performance: Idle @ 28°C Ambient							
L _{WA,m} ⁽¹⁾ (B)		7.3	5.4	5.9	6.7	7.3	7.1
K _v (B)		0.4	0.4	0.4	0.4	0.4	0.4
L _{pA,m} ⁽²⁾ (dB)		52	35	45	45	52	49
Acoustical Performance: Max. loading @ 35°C Ambient							
L _{WA,m} ⁽¹⁾ (B)		9.0	40.3	7.0	7.8	9.0	7.8
K _v (B)		0.4	0.4	0.4	0.4	0.4	0.4
L _{pA,m} ⁽²⁾ (dB)		70	35	58	59	70	58

⁽¹⁾L_{WA,m}: The declared mean A-weighted sound power level (L_{WA}) is calculated per section 5.2 of ISO 9296 (2017) with data collected using the methods that are described in ISO 7779 (2010). Engineering data presented here may not be fully compliant with ISO 7779 declaration requirement.

⁽²⁾L_{pA,m}: The declared mean A-weighted emission sound pressure level is at the bystander position per section 5.3 of ISO 9296 (2017) and measured using methods that are described in ISO 7779 (2010). The system is placed in a 24U rack enclosure, 25 cm above a reflective floor. Engineering data presented here may not be fully compliant with ISO 7779 declaration requirement.

⁽³⁾Prominent tones: Criteria of Annex D of ECMA-74 and Prominence Ratio method of ECMA-418 are followed to determine if discrete tones are prominent and to report them, if so.

⁽⁴⁾Idle mode: The steady-state condition in which the server is energized but not operating any intended function.

(5) Operating mode: The maximum of the steady state acoustical output at 50% of CPU TDP or active storage drives for the respective sections of Annex C of ECMA-74.

(6) Customer Usage Operating mode: The operating mode is represented by the maximum of the steady state acoustical output at 25%~30% of CPU TDP, 2.5%~10% IOPs load, and >80% GPU load as the components showed in the above configurations.

PowerEdge acoustical specifications

For more information about acoustical specifications, see ENG0019663. (See the category definitions.)

Dell typically categorizes servers in five categories of acoustically acceptable usage:

- Category 1: Table-top in Office Environment
- Category 2: Floor-standing in Office Environment
- Category 3: General Use Space
- Category 4: Attended Data Center
- Category 5: Unattended Data Center

Category 1: Floor-standing in Office Environment

When Dell determines that a specific Enterprise product is to be used on a table-top in office environment, for example, on a desk around a seated user’s head height, and then the acoustical specification of the following table applies. Small, light-weight towers are examples of these types of products.

Table 18. Dell Enterprise Category 1, “Table-top in Office Environment” acoustical specification category.

Measurement Position re AC0158	Metric, re AC0159	Test Modes, re AC0159 (note must be in steady state, see AC0159, except where noted below)			
		Standby in 23±2° C Ambient	Idle in 23±2° C Ambient	Operating in 23±2° C Ambient – if not otherwise specified in the program’s configuration document, then processor and hard drive operating modes are required	Simulate (that is, set fan speeds representative) for Idle at 28° C & 35° C Ambient, and for 100% loading and maximum configuration, at 35° C Ambient
Sound Power	LwA-m, bels	≤ 4.2	≤ 4.7	≤ 5.0	Report
Sound Quality (both positions must meet limits): Front Binaural HEAD and Rear Microphone	Tones, Hz, dB	No prominent tones per criteria D.10.6 and D.10.8 of ECMA-74			Report tones
	Tonality, tu	≤ 0.35	≤ 0.35	≤ 0.35	Report
	Dell Modulation, %	≤ 35	≤ 35	≤ 35	Report
	Loudness, sones	Report	Report	Report	Report
	LpA-single point, dBA	Report	Report	Report	Report
Front Binaural HEAD	Transients	<ul style="list-style-type: none"> • Oscillation (see AC0159), if observed, during 20-minute steady-state observation, must adhere to the following two criteria: <ul style="list-style-type: none"> ○ Max. {ΔLpA} < 3.0 dB ○ Event count < 3 for “1.5 dB < ΔLpA < 3.0 dB” ○ Acoustical Jump (see AC0159), during air mover speed transition from Idle to Operating Mode must be ≤ 15 dB. 			N/A

Table 18. Dell Enterprise Category 1, “Table-top in Office Environment” acoustical specification category. (continued)

Measurement Position re AC0158	Metric, re AC0159	Test Modes, re AC0159 (note must be in steady state, see AC0159, except where noted below)			
		Standby in 23±2° C Ambient	Idle in 23±2° C Ambient	Operating in 23±2° C Ambient – if not otherwise specified in the program’s configuration document, then processor and hard drive operating modes are required	Simulate (that is, set fan speeds representative) for Idle at 28° C & 35° C Ambient, and for 100% loading and maximum configuration, at 35° C Ambient
		<ul style="list-style-type: none"> ● Startup behavior <ul style="list-style-type: none"> ○ Report Startup behavior re. AC0159 ○ Startup must proceed smoothly, that is, no sudden or large jumps, and fan speed during startup must not exceed 50% of its maximum ● Transient inputs: Report time-history sound pressure levels re AC0159 “Train of Step Functions on Processor” 			
Any	Other	<p>No rattles, squeaks, or unexpected noises</p> <p>Sound should be “even” around the EUT (one side should not be dramatically louder than another)</p> <p>Unless otherwise specified, the “default” thermal-related settings shall be selected for BIOS and iDRAC.</p> <p>Specific operating conditions will be defined in “Configurations & Configuration Dependencies” for each platform.</p>			
Sound Pressure	LpA-reported, dBA, re AC0158 and program configuration document	Report for all mics	Report for all mics	Report for all mics	Report for all mics

Category 2: Floor-standing in Office Environment

When Dell determines that a specific Enterprise product is to be used primarily when it is sitting on the floor, that is, next to a user’s feet, then the acoustical specification in the table below applies. Noise from the product should not annoy or otherwise interfere with the user’s thoughts or speech, for example, on the telephone.

Table 19. Dell Enterprise Category 2, “Floor-standing in Office Environment” acoustical specification category

Measurement Position re AC0158	Metric, re AC0159	Test Modes, re AC0159 (note must be in steady state, see AC0159, except where noted below)			
		Standby in 23±2° C Ambient	Idle in 23±2° C Ambient	Operating in 23±2° C Ambient – if not otherwise specified in the program’s configuration document, then processor and hard drive operating modes are required	Simulate (that is, set fan speeds representative) for Idle at 28° C & 35° C Ambient, and for 100% loading and maximum configuration, at 35° C Ambient
Sound Power	LwA-m, bels	≤ 4.9	≤ 5.1	≤ 5.4	Report
Sound Quality (both positions must meet limits): Front Binaural HEAD and Rear Microphone	Tones, Hz, dB	No prominent tones per criteria D.10.6 and D.10.8 of ECMA-74			Report tones
	Tonality, tu	≤ 0.35	≤ 0.35	≤ 0.35	Report
	Dell Modulation, %	≤ 35	≤ 35	≤ 35	Report
	Loudness, sones	Report	Report	Report	Report
	LpA-single point, dBA	Report	Report	Report	Report
Front Binaural HEAD	Transients	<ul style="list-style-type: none"> ● Oscillation (see AC0159), if observed, during 20-minute steady-state observation, must adhere to the following two criteria: <ul style="list-style-type: none"> ○ Max. {ΔLpA} < 3.0 dB ○ Event count < 3 for “1.5 dB < ΔLpA < 3.0 dB” ● Acoustical Jump (see AC0159), during air mover speed transition from Idle to Operating Mode must be ≤ 15 dB. ● Startup behavior <ul style="list-style-type: none"> ○ Report Startup behavior re. AC0159 ○ Startup must proceed smoothly, that is, no sudden or large jumps, and fan speed during startup must not exceed 50% of its maximum ● Transient inputs: Report time-history sound pressure levels re AC0159 “Train of Step Functions on Processor” 			N/A
Any	Other	<ul style="list-style-type: none"> ● No rattles, squeaks, or unexpected noises ● Sound should be “even” around the EUT (one side should not be dramatically louder than another) ● Unless otherwise specified, the “default” thermal-related settings shall be selected for BIOS and iDRAC. ● Specific operating conditions are defined in “Configurations and Configuration Dependencies” for each platform. 			
Sound Pressure	LpA-reported, dBA, re AC0158 and program configuration document	Report for all mics	Report for all mics	Report for all mics	Report for all mics

Category 3: General Use Space

When Dell determines that a specific Enterprise product is to be predominantly used in a general use space, then the acoustical specification of the table below applies. These products could be found in laboratories, schools, restaurants, open office space layouts, small ventilated closets, etc., though not in close proximity to any particular person nor in quantities greater than a few in any location. People within proximity of a few of these products should not experience any impact to speech intelligibility or annoyance from the noise of the product. A rack product sitting on a table in a common area is an example.

Table 20. Dell Enterprise Category 3, “General Use” acoustical specification category

Measurement Position re AC0158	Metric, re AC0159	Test Modes, re AC0159 (note must be in steady state, see AC0159, except where noted below)			
		Standby in 23±2° C Ambient	Idle in 23±2° C Ambient	Operating in 23±2° C Ambient – if not otherwise specified in the program’s configuration document, then processor and hard drive operating modes are required	Simulate (that is, set air mover speeds representative) for Idle at 28° C & 35° C Ambient and for 100% loading and maximum configuration, at 35° C Ambient
Sound Power	LwA-m, bels	≤ 5.2	≤ 5.5	≤ 5.8	Report
Sound Quality (both positions must meet limits): Front Binaural HEAD and Rear Microphone	Tones, Hz, dB	No prominent tones per criteria D.10.6 and D.10.8 of ECMA-74			Report tones
	Tonality, tu	≤ 0.35	≤ 0.35	≤ 0.35	Report
	Dell Modulation, %	≤ 40	≤ 40	≤ 40	Report
	Loudness, sones	Report	Report	Report	Report
	LpA-single point, dBA	Report	Report	Report	Report
Front Binaural HEAD	Transients	<ul style="list-style-type: none"> ● Oscillation (see AC0159), if observed, during 20-minute steady-state observation, must adhere to the following two criteria: <ul style="list-style-type: none"> ○ Max. {ΔLpA} < 3.0 dB ○ Event count < 3 for “1.5 dB < ΔLpA < 3.0 dB” ● Report Acoustical Jump (see AC0159) during air mover speed transition from Idle to Operating Mode. ● Startup behavior <ul style="list-style-type: none"> ○ Report Startup behavior re. AC0159 ○ Startup must proceed smoothly, that is, no sudden or large jumps, and air mover speed during startup must not exceed 50% of its maximum ● Transient inputs: Report time-history sound pressure levels re AC0159 “Train of Step Functions on Processor” 			N/A
Any	Other	<p>No rattles, squeaks, or unexpected noises</p> <p>Sound should be “even” around the EUT (one side should not be dramatically louder than another)</p> <p>Unless otherwise specified, the “default” thermal-related settings shall be selected for BIOS and iDRAC.</p>			

Table 20. Dell Enterprise Category 3, “General Use” acoustical specification category (continued)

Measurement Position re AC0158	Metric, re AC0159	Test Modes, re AC0159 (note must be in steady state, see AC0159, except where noted below)			
		Standby in 23±2° C Ambient	Idle in 23±2° C Ambient	Operating in 23±2° C Ambient – if not otherwise specified in the program’s configuration document, then processor and hard drive operating modes are required	Simulate (that is, set air mover speeds representative) for Idle at 28° C & 35° C Ambient and for 100% loading and maximum configuration, at 35° C Ambient
		Specific operating conditions will be defined in “Configurations & Configuration Dependencies” for each platform.			
Sound Pressure	LpA-reported, dBA, re AC0158 and program configuration document	Report for all mics	Report for all mics	Report for all mics	Report for all mics

Category 4: Attended Data Center

When Dell determines that a specific Enterprise product is to be predominantly used in an attended data center, then the acoustical specification of the table applies. The phrase “attended data center” is used to mean a space in which many (from tens to 1000s) of Enterprise products are deployed in proximity (that is, in the same room) to personnel whose speech (perhaps with raised voices) is expected to be intelligible over the data center noise. Hearing protection or hearing monitoring programs are not expected in these areas. Examples in this category include monolithic rack products.

Table 21. Dell Enterprise Category 4, “Attended Data Center” acoustical specification category.

Measurement Position re AC0158	Metric, re AC0159	Test Modes, re AC0159 (note must be in steady state, see AC0159, except where noted below)				Simulate (that is, set fan speeds representative) for 100% loading and maximum configuration, at 35° C Ambient
		Standby in 23±2° C Ambient	Idle in 23±2° C Ambient	Operating in 23±2° C Ambient – if not otherwise specified in the program’s configuration document, then processor and hard drive operating modes are required	Simulate (that is, set fan speeds representative) for Idle at 28° C & 35° C Ambient	
Sound Power	LwA-m, B	Report	≤ 6.9	≤ 7.1	Report	≤ 8.2
Front Binaural HEAD	Tones, Hz, dB	Report	< 15 dB	< 15 dB	Report	< 20 dB
	Tonality, tu	Report	Report	Report	Report	Report
	Dell Modulation, %	Report	Report	Report	Report	Report
	Loudness, sones	Report	Report	Report	Report	Report
	LpA-single point, dBA	Report	Report	Report	Report	Report

Table 21. Dell Enterprise Category 4, “Attended Data Center” acoustical specification category. (continued)

Measurement Position re AC0158	Metric, re AC0159	Test Modes, re AC0159 (note must be in steady state, see AC0159, except where noted below)				Simulate (that is, set fan speeds representative) for 100% loading and maximum configuration, at 35° C Ambient
		Standby in 23±2° C Ambient	Idle in 23±2° C Ambient	Operating in 23±2° C Ambient – if not otherwise specified in the program’s configuration document, then processor and hard drive operating modes are required	Simulate (that is, set fan speeds representative) for Idle at 28° C & 35° C Ambient	
	Transients	<ul style="list-style-type: none"> ● Oscillation (see AC0159), if observed, during 20-minute steady-state observation, must adhere to the following two criteria: <ul style="list-style-type: none"> ○ Max. {ΔLpA} < 3.0 dB ○ Event count < 3 for “1.5 dB < ΔLpA < 3.0 dB” ○ Acoustical Jump (see AC0159), during air mover speed transition from Idle to Operating Mode must be ≤ 15 dB. ○ Startup behavior <ul style="list-style-type: none"> ■ Report Startup behavior re. AC0159 ■ Startup must proceed smoothly, that is, no sudden or large jumps, and fan speed during startup must not exceed 50% of its maximum ∞ Transient inputs: Report time-history sound pressure levels re AC0159 “Train of Step Functions on Processor” 				N/A
Any	Other	<p>No rattles, squeaks, or unexpected noises</p> <p>Sound should be “even” around the EUT (one side should not be dramatically louder than another)</p> <p>Unless otherwise specified, the “default” thermal-related settings shall be selected for BIOS and iDRAC.</p> <p>Specific operating conditions will be defined in “Configurations & Configuration Dependencies” for each platform.</p>				
Sound Pressure	LpA-reported, dBA	Report for all mics	Report for all mics	Report for all mics	Report for all mics	Report for all mics

Category 5: Unattended Data Center

When Dell determines that a specific Enterprise product is to be predominantly used in an unattended data center (and not blades or blade enclosures; these have their own category), then the acoustical specification in the table below applies. The phrase “unattended data center” is used to mean a space in which many (from tens to 1000s) of Enterprise products are deployed together, its own heating and cooling systems condition the space, and operators or servicers of equipment enter generally only to deploy, service, or decommission equipment. Hearing protection or hearing monitoring programs may be expected (per government or company guidelines) in these areas. Examples in this category include monolithic rack products.

Table 22. Dell Enterprise Category 5, “Unattended Data Center” acoustical specification category

Measurement Position re AC0158	Metric, re AC0159	Test Modes, re AC0159 (note must be in steady state, see AC0159, except where noted below)				Simulate (that is, set air mover speeds representative) for 100% loading and maximum configuration, at 35° C Ambient
		Standby in 23±2° C Ambient	Idle in 23±2° C Ambient	Operating in 23±2° C Ambient – if not otherwise specified in the program’s configuration document, then processor and hard drive operating modes are required	Simulate (that is, set air mover speeds representative) for Idle at 28° C & 35° C Ambient	
Sound Power	LwA-m, bels	Report	≤ 7.5	≤ 7.7	Report	≤ 8.7
Front Binaural HEAD	Tones, Hz, dB	Report	< 15 dB	< 15 dB	Report	< 20 dB
	Tonality, tu	Report	Report	Report	Report	Report
	Dell Modulation, %	Report	Report	Report	Report	Report
	Loudness, sones	Report	Report	Report	Report	Report
	LpA-single point, dBA	Report	Report	Report	Report	Report
Front Binaural HEAD	Transients	<ul style="list-style-type: none"> Oscillation (see AC0159), if observed, during 20-minute steady-state observation, must adhere to the following two criteria: <ul style="list-style-type: none"> Max. {ΔLpA} < 3.0 dB Event count < 3 for “1.5 dB < ΔLpA < 3.0 dB” Report Acoustical Jump (see AC0159) during air mover speed transition from Idle to Operating Mode. Startup behavior <ul style="list-style-type: none"> Report Startup behavior re. AC0159 Startup must proceed smoothly, that is, no sudden or large jumps, and air mover speed during startup must not exceed 50% of its maximum Transient inputs: Report time-history sound pressure levels re AC0159 “Train of Step Functions on Processor” 			N/A	
Any	Other	<p>No rattles, squeaks, or unexpected noises</p> <p>Sound should be “even” around the EUT (one side should not be dramatically louder than another)</p> <p>Unless otherwise specified, the “default” thermal-related settings shall be selected for BIOS and iDRAC.</p> <p>Specific operating conditions will be defined in “Configurations & Configuration Dependencies” for each platform.</p>				

Table 22. Dell Enterprise Category 5, “Unattended Data Center” acoustical specification category (continued)

Measurement Position re AC0158	Metric, re AC0159	Test Modes, re AC0159 (note must be in steady state, see AC0159, except where noted below)				Simulate (that is, set air mover speeds representative) for 100% loading and maximum configuration, at 35° C Ambient
		Standby in 23±2° C Ambient	Idle in 23±2° C Ambient	Operating in 23±2° C Ambient – if not otherwise specified in the program’s configuration document, then processor and hard drive operating modes are required	Simulate (that is, set air mover speeds representative) for Idle at 28° C & 35° C Ambient	
Sound Pressure	LpA-reported, dBA, re AC0158 and program configuration document	Report for all mics	Report for all mics	Report for all mics	Report for all mics	Report for all mics

Rack, rails, and cable management

Topics:

- [Rails and cable management information](#)

Rails and cable management information

The rail offerings for the PowerEdge R760 consist of two general types: sliding and static. The cable management offerings consist of an optional cable management arm (CMA) and an optional strain relief bar (SRB).

See the *Enterprise Systems Rail Sizing and Rack Compatibility Matrix* available at https://i.dell.com/sites/csdocuments/Business_solutions_engineering-Docs_Documents/en/rail-rack-matrix.pdf for information regarding:

- Specific details about rail types.
- Rail adjustability ranges for various rack mounting flange types.
- Rail depth with and without cable management accessories.
- Rack types that are supported for various rack mounting flange types.

Key factors governing proper rail selection include the following:

- Spacing between the front and rear mounting flanges of the rack.
- Type and location of any equipment that is mounted in the back of the rack such as power distribution units (PDUs).
- Overall depth of the rack.

Sliding rails features summary

The sliding rails allow the system to be fully extended out of the rack for service. There are two types of sliding rails available, ReadyRails II sliding rails and Stab-in/Drop-in sliding rails. The sliding rails are available with or without the optional cable management arm (CMA) or strain relief bar (SRB).

B21 ReadyRails sliding rails for 4-post racks

- Supports drop-in installation of the chassis to the rails.
- Support for tool-less installation in 19" EIA-310-E compliant square or unthreaded round hole 4-post racks including all generations of the Dell racks.
- Support for tooled installation in 19" EIA-310-E compliant threaded hole 4-post racks.
- Support full extension of the system out of the rack to allow serviceability of key internal components.
- Support for optional strain relief bar (SRB).
- Support for optional cable management arm (CMA).

i **NOTE:** For situations where CMA support is not required, the outer CMA mounting brackets can be uninstalled from the sliding rails. This reduces the overall length of the rails and eliminates the potential interferences with rear-mounted PDUs or the rear rack door.

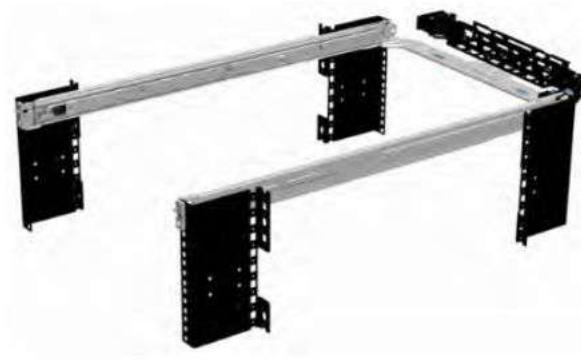

Figure 33. Sliding rails with optional CMA



Figure 34. Sliding rails with optional SRB

B22 Stab-in/Drop-in sliding rails for 4-post racks

- Supports drop-in or stab-in installation of the chassis to the rails.
- Support for tool-less installation in 19" EIA-310-E compliant square, unthreaded round hole racks including all generations of the Dell racks. Also supports tool-less installation in threaded round hole 4-post racks.
- Support for tool-less installation in Dell Titan or Titan-D racks.
- Support full extension of the system out of the rack to allow serviceability of key internal components.
- Support for optional cable management arm (CMA).
- Support for optional strain relief bar (SRB).

NOTE: For situations where CMA support is not required, the outer CMA mounting brackets can be uninstalled from the sliding rails. This reduces the overall length of the rails and eliminates the potential interferences with rear-mounted PDUs or the rear rack door.

Scan the QRL code for the documentation and trouble-shooting information regarding the installation procedures for Drop-in/Stab-in rail types.



Figure 35. Quick resource locator for combo rails

B20 static rails summary

The static rails offer a greater adjustability range and a smaller overall mounting footprint than the sliding rails because of their reduced complexity and lack of need for CMA support. The static rails support a wider variety of racks than the sliding rails. However, they do not support serviceability in the rack and are thus not compatible with the CMA. The static rails are also not compatible with SRB.



Figure 36. Static rails

Static rails features summary

Static rails for 4-post and 2-post racks:

- Supports Stab-in installation of the chassis to the rails.
- Support tool-less installation in 19" EIA-310-E compliant square or unthreaded round hole 4-post racks including all generations of Dell racks.
- Support tool installation in 19" EIA-310-E compliant threaded hole 4-post and 2-post racks.
- Support for tool installation in Dell Titan or Titan-D rack.

i NOTE:

- Screws are not included with the static rail kit since racks are offered with various thread types. The screws are provided for mounting static rails in racks with threaded mounting flanges.
- Screw head diameter should be 10 mm or less.

2-Post racks installation

If installing to 2-Post (Telco) racks, the ReadyRails II static rails (B20) must be used. Sliding rails support mounting in 4-post racks only.



Figure 37. Static rails in 2-post center mount configuration

Installation in the Dell Titan or Titan-D racks

For tool-less installation in Titan or Titan-D racks, the Stab-in/Drop-in sliding rails (B22) must be used. This rail collapses down sufficiently to fit in the rack with mounting flanges that are spaced about 24 inches apart from front to back. The Stab-in/Drop-in sliding rail allows bezels of the servers and storage systems to be aligned when installed in these racks. For tool installation, Stab-in Static rails (B20) must be used for bezel alignment with storage systems.

Cable management arm (CMA)

The optional cable management arm (CMA) organizes and secures the cords and cables exiting the back of the systems. It unfolds to allow the systems to extend out of the rack without having to detach the cables. Some key features of the CMA include:

- Large U-shaped baskets to support dense cable loads.
- Open vent pattern for optimal airflow.
- Ability to mount on either side by swinging the spring-loaded brackets from one side to the other.
- Utilizes hook-and-loop straps rather than plastic tie wraps to eliminate the risk of cable damage during cycling.
- Includes a low-profile fixed tray to both support and retain the CMA in its fully closed position.
- Both the CMA and the tray mount without the use of tools by simple and intuitive snap-in designs.

NOTE: CMA is not supported in Direct Liquid Cooling configuration.

The CMA can be mounted to either side of the sliding rails without the use of tools or the need for conversion. For systems with one power supply unit (PSU), it is recommended to mount on the side opposite to that of the power supply to allow easier access to it and the rear drives (if applicable) for service or replacement.

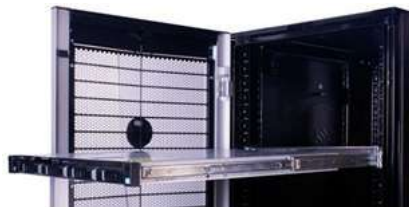

Figure 38. Sliding rails with CMA

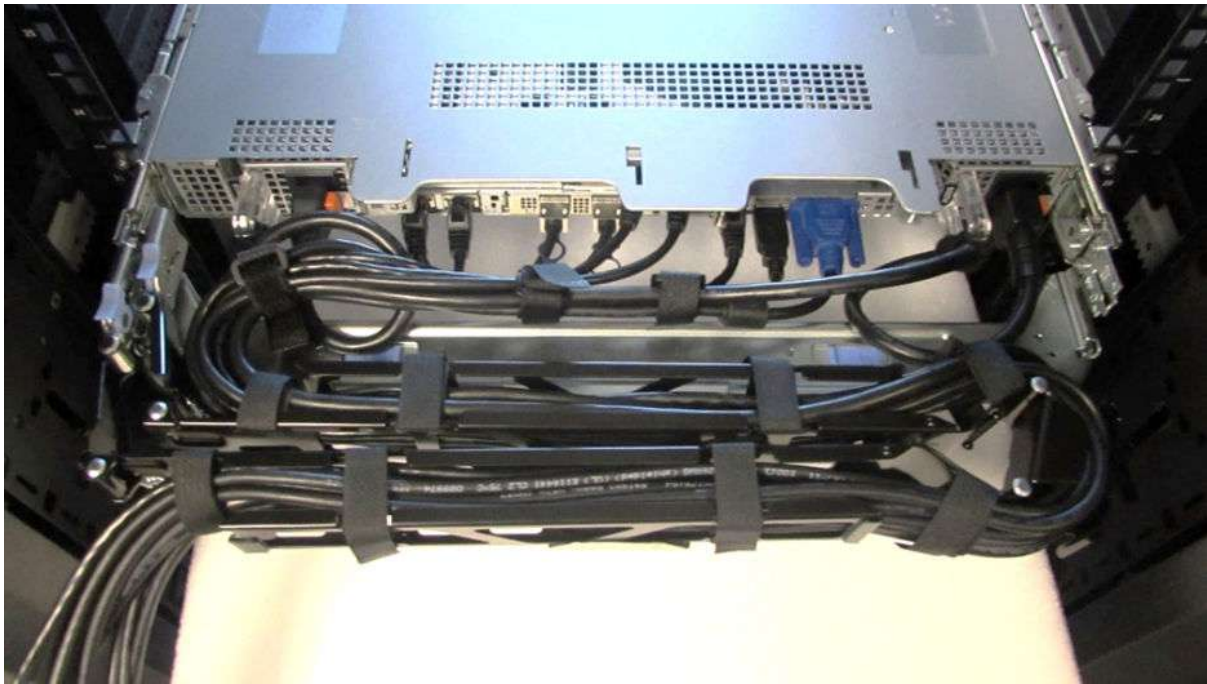

Figure 39. CMA Cabling

Strain Relief Bar (SRB)

The optional strain relief bar (SRB) for the PowerEdge R760 organizes and supports cable connections at the rear end of the server to avoid damage from bending.

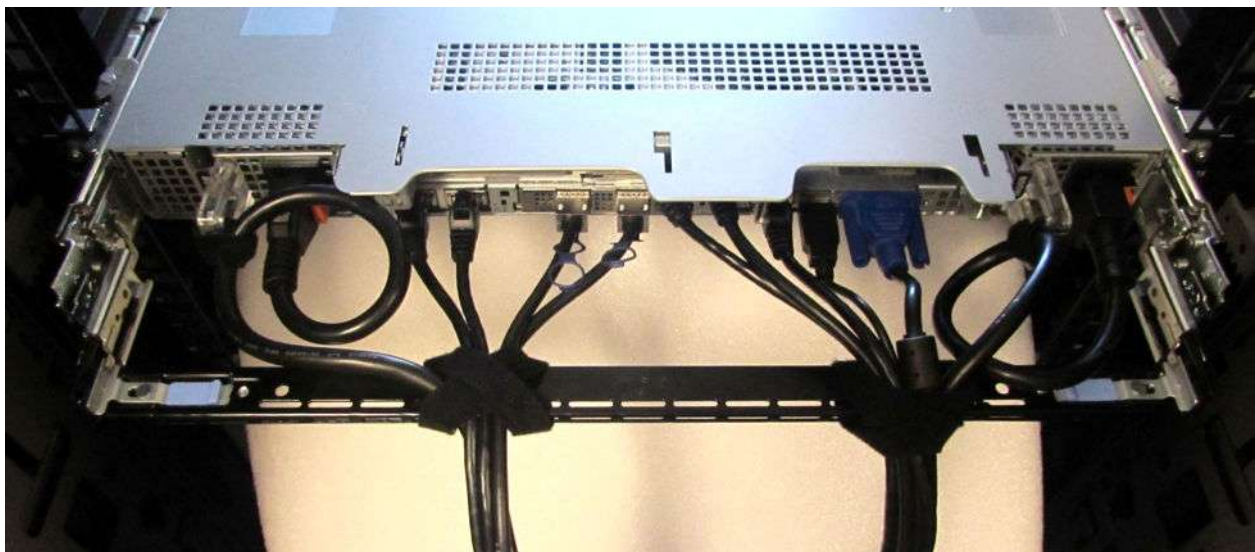

Figure 40. Cabled strain relief bar

- Tool-less attachment to the rails
- Two depth positions to accommodate various cable loads and rack depths
- Supports cable loads and controls stresses on server connectors
- Cables can be segregated into discrete purpose-specific bundles

Rack Installation

Drop-in design means that the system is installed vertically into the rails by inserting the standoffs on the sides of the system into the J-slots in the inner rail members with the rails in the fully extended position. The recommended method of installation is to first insert the rear standoffs on the system into the rear J-slots on the rails to free up a hand and then rotate the system down into the remaining J-slots while using the free hand to hold the rail against the side of the system.

Stab-in design means that the inner (chassis) rail members must first be attached to the sides of the system and then inserted into the outer (cabinet) members installed in the rack.

Installing system into the rack (option A: Drop-In)

1. Pull the inner rails out of the rack until they lock into place.



Figure 41. Pull out inner rail

2. Locate the rear rail standoff on each side of the system and lower them into the rear J-slots on the slide assemblies.
3. Rotate the system downward until all the rail standoffs are seated in the J-slots.

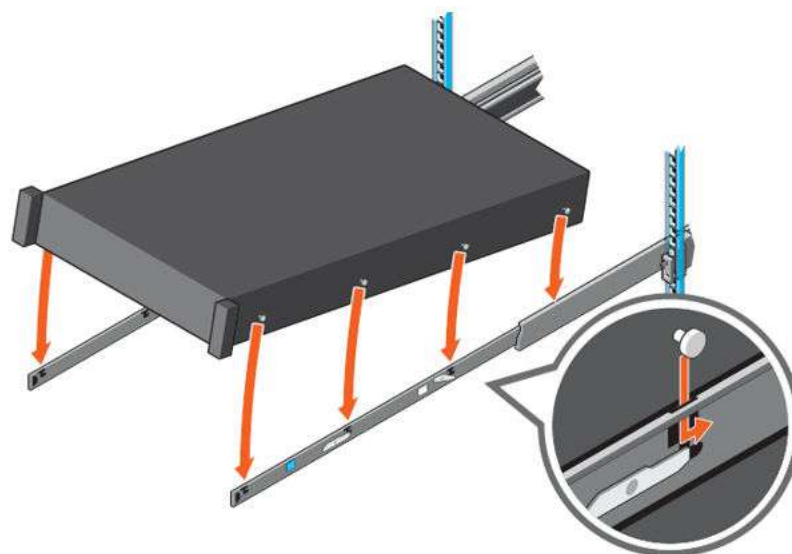

Figure 42. Rail standoffs seated in J-slots

4. Push the system inward until the lock levers click into place.

5. Pull the blue side release lock tabs forward or backward on both rails and slide the system into the rack until the system is in the rack.

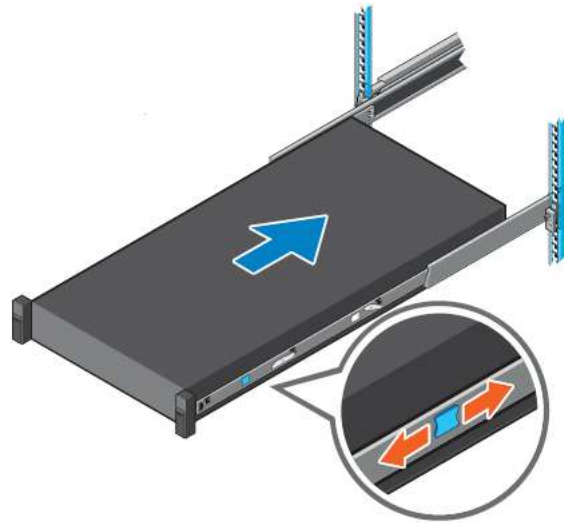

Figure 43. Slide system into the rack

Installing the system into the rack (option B: Stab-In)

1. Pull the intermediate rails out of the rack until they lock into place.
2. Release the inner rail lock by pulling forward on the white tabs and sliding the inner rail out of the intermediate rails.

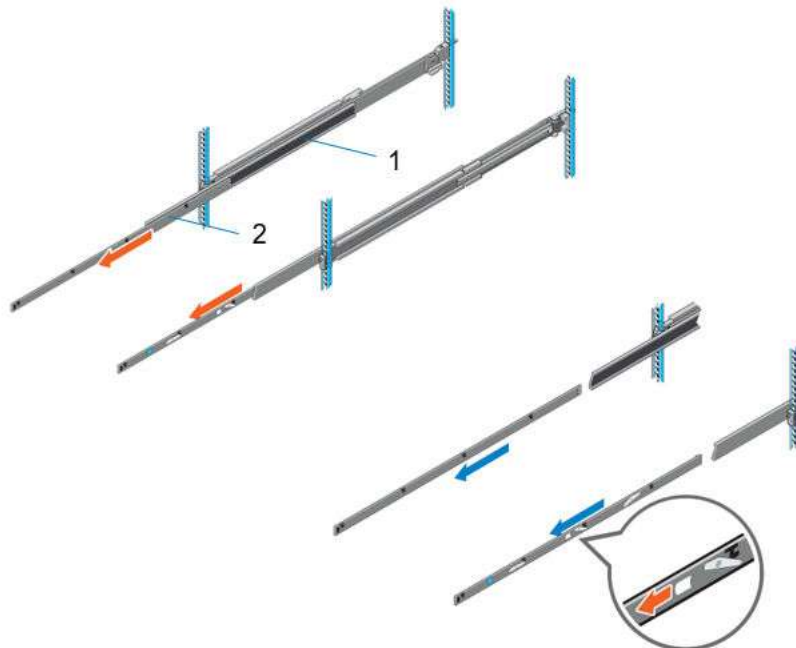

Figure 44. Pull out the intermediate rail

Table 23. Rail component label

Number	Component
1	Intermediate rail
2	Inner rail

3. Attach the inner rails to the sides of the system by aligning the J-slots on the rail with the standoffs on the system and sliding forward on the system until they lock into place.

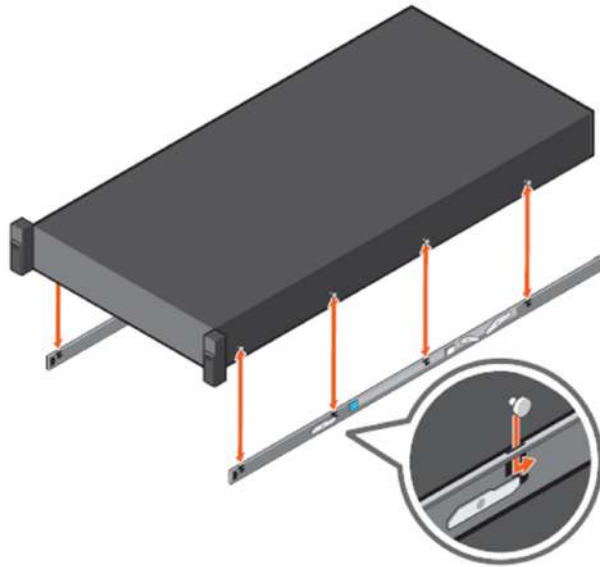

Figure 45. Attach the inner rails to the system

4. With the intermediate rails extended, install the system into the extended rails.

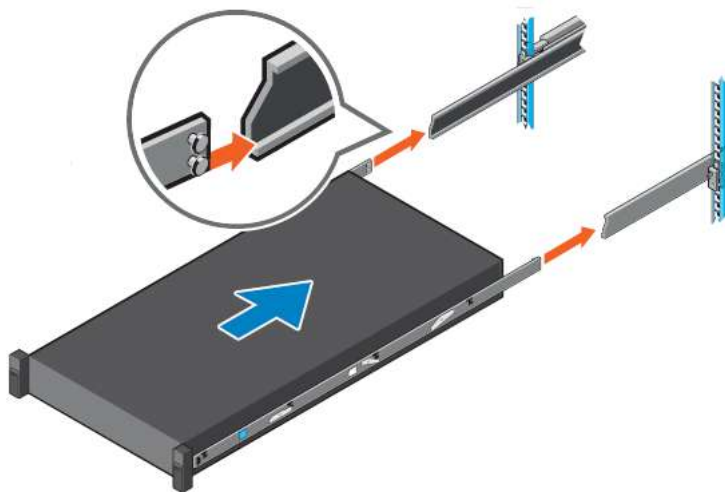

Figure 46. Install system into the extended rails

5. Pull blue slide release lock tabs forward or backward on both rails, and slide the system into the rack.

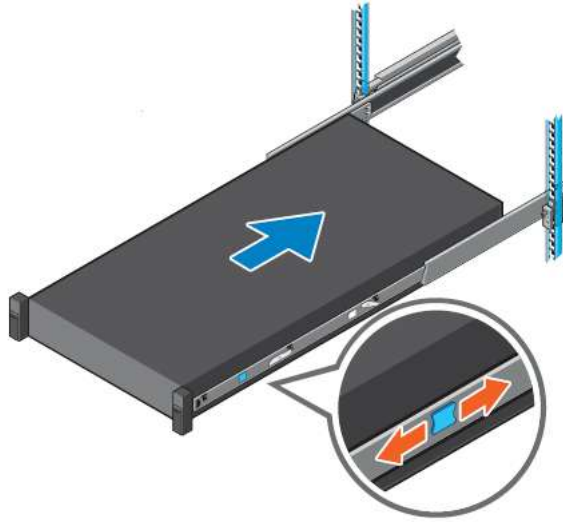

Figure 47. Slide system into the rack

Operating Systems and Virtualization

Topics:

- [Supported Operating Systems](#)

Supported Operating Systems

The PowerEdge system supports the following operating systems:

- Canonical® Ubuntu® Server LTS
- Microsoft® Windows Server® with Hyper-V
- Red Hat® Enterprise Linux
- SUSE® Linux Enterprise server
- VMware® ESXi®

Links to specific OS versions and editions, certification matrices, Hardware Compatibility Lists (HCL) portal, and Hypervisor support are available at [Dell Enterprise Operating Systems](#).

Dell OpenManage Systems Management

Dell delivers management solutions that help IT administrators effectively deploy, update, monitor, and manage IT assets. OpenManage solutions and tools enable you to quickly respond to problems by helping them to manage Dell servers efficiently; in physical, virtual, local, and remote environments; all without the need to install an agent in the operating system.

The OpenManage portfolio includes:

- Innovative embedded management tools - integrated Dell Remote Access Controller (iDRAC)
- Consoles - OpenManage Enterprise
- Extensible with plug-ins - OpenManage Power Manager
- Update tools - Repository Manager

Dell has developed comprehensive systems management solutions that are based on open standards and has integrated with management consoles from partners such as Microsoft and VMware, allowing advanced management of Dell servers. Dell management capabilities extend to offerings from the industry's top systems management vendors and frameworks such as Ansible, Splunk, and ServiceNow. OpenManage tools automate the full span of server life cycle management activities along with powerful RESTful APIs to script or integrate with your choice of frameworks.

For more information about the entire OpenManage portfolio, see:

- The latest [Dell Systems Management Overview Guide](#).

Topics:

- [Integrated Dell Remote Access Controller \(iDRAC\)](#)
- [Systems Management software support matrix](#)

Integrated Dell Remote Access Controller (iDRAC)

iDRAC9 delivers advanced, agent-free, local and remote server administration. Embedded in every PowerEdge server, iDRAC9 provides a secure means to automate a multitude of common management tasks. Because iDRAC is embedded within every PowerEdge server, there is no additional software to install; just plug in power and network cables, and iDRAC is ready to go. Even before installing an operating system (operating system) or hypervisor, IT administrators have a complete set of server management features at their fingertips.

With iDRAC9 in-place across the Dell PowerEdge portfolio, the same IT administration techniques and tools can be applied throughout. This consistent management platform allows easy scaling of PowerEdge servers as an organization's infrastructure grows. Customers can use the iDRAC RESTful API for the latest in scalable administration methods of PowerEdge servers. With this API, iDRAC enables support for the Redfish standard and enhances it with Dell extensions to optimize at-scale management of PowerEdge servers. By having iDRAC at the core, the entire OpenManage portfolio of Systems Management tools allows every customer to tailor an effective, affordable solution for any size environment.

Zero Touch Provisioning (ZTP) is embedded in iDRAC. ZTP - Zero Touch Provisioning is Intelligent Automation Dell's agent-free management puts IT administrators in control. Once a PowerEdge server is connected to power and networking, that system can be monitored and fully managed, whether you're standing in front of the server or remotely over a network. In fact, with no need for software agents, an IT administrator can: · Monitor · Manage · Update · Troubleshoot and remediate Dell servers With features like zero-touch deployment and provisioning, iDRAC Group Manager, and System Lockdown, iDRAC9 is purpose-built to make server administration quick and easy. For those customers whose existing management platform utilizes in-band management, Dell does provide iDRAC Service Module, a lightweight service that can interact with both iDRAC9 and the host operating system to support legacy management platforms.

When ordered with DHCP enabled from the factory, PowerEdge servers can be automatically configured when they are initially powered up and connected to your network. This process uses profile-based configurations that ensure each server is configured per your specifications. This feature requires an iDRAC Enterprise license.

iDRAC9 offers following license tiers:

Table 24. iDRAC9 license tiers

License	Description
iDRAC9 Basic	<ul style="list-style-type: none"> Available only on 100-500 series rack/tower Basic instrumentation with iDRAC web UI For cost conscious customers that see limited value in management
iDRAC9 Express	<ul style="list-style-type: none"> Default on 600+ series rack/tower, modular, and XR series Includes all features of Basic Expanded remote management and server life-cycle features
iDRAC9 Enterprise	<ul style="list-style-type: none"> Available as an upsell on all servers Includes all features of Basic and Express. Includes key features such as virtual console, AD/LDAP support, and more Remote presence features with advanced, Enterprise-class, management capabilities
iDRAC9 Datacenter	<ul style="list-style-type: none"> Available as an upsell on all servers Includes all features of Basic, Express, and Enterprise. Includes key features such as telemetry streaming, Thermal Manage, automated certificate management, and more Extended remote insight into server details, focused on high end server options, granular power, and thermal management

For a full list of iDRAC features by license tier, see [Integrated Dell Remote Access Controller 9 User's Guide](#) at [Dell.com](#).

For more details on iDRAC9 including white papers and videos, see:

- Support for [Integrated Dell Remote Access Controller 9 \(iDRAC9\)](#) on the [Knowledge Base](#) page at [Dell.com](#)

Systems Management software support matrix

Table 25. Systems Management software support matrix

Categories	Features	PE mainstream
Embedded Management and In-band Services	iDRAC9 (Express, Enterprise, and Datacenter licenses)	Supported
	OpenManage Mobile	Supported
	OM Server Administrator (OMSA)	Supported
	iDRAC Service Module (iSM)	Supported
	Driver Pack	Supported
Change Management	Update Tools (Repository Manager, DSU, Catalogs)	Supported
	Server Update Utility	Supported
	Lifecycle Controller Driver Pack	Supported
	Bootable ISO	Supported
Console and Plug-ins	OpenManage Enterprise	Supported
	Power Manager Plug-in	Supported
	Update Manager Plug-in	Supported
	SupportAssist Plug-in	Supported
	CloudIQ	Supported
Integrations and connections	OM Integration with VMware Vcenter/vROps	Supported
	OM Integration with Microsoft System Center (OMIMSC)	Supported
	Integrations with Microsoft System Center and Windows Admin Center (WAC)	Supported

Table 25. Systems Management software support matrix (continued)

Categories	Features	PE mainstream
	ServiceNow	Supported
	Ansible	Supported
	Third-party Connectors (Nagios, Tivoli, Microfocus)	Supported
Security	Secure Enterprise Key Management	Supported
	Secure Component Verification	Supported
Standard operating system	Red Hat Enterprise Linux, SUSE, Windows Server 2021 Ubuntu, CentOS	Supported (Tier-1)

Appendix D: Service and support

Topics:

- [Default support levels](#)
- [Other services and support information](#)

Default support levels

This system offers 3 years Dell ProSupport Next Business Day (NBD), including 24x7 phone support and NBD parts and labor support.

Default deployment levels

This system is defaulted to the ProDeploy Dell Server which includes onsite hardware installation and remote software configuration. Optionally, the customer may choose to any of the factory or field deployment offers listed below.

Other services and support information

Dell Technologies Services include a wide, customizable range of service options to simplify the assessment, design, implementation, management and maintenance of IT environments and to help transition from platform to platform.

Depending on the current business requirements and correct level of service for customers, we provide factory, onsite, remote, modular, and specialized services that fit the customer requirements and budget. We will help with a little or a lot, based on the customers choice, and provide access to our global resources.

Dell deployment services

[Dell ProDeploy Infrastructure Suite](#)

ProDeploy Infrastructure Suite provides a variety of deployment offerings that satisfy a customer's unique needs. It is made up of 5 offers: ProDeploy Configuration Services, ProDeploy Rack Integration Services, Basic Deployment, ProDeploy, and ProDeploy Plus.

ProDeploy Infrastructure Suite for servers

Versatile choices for accelerated deployments

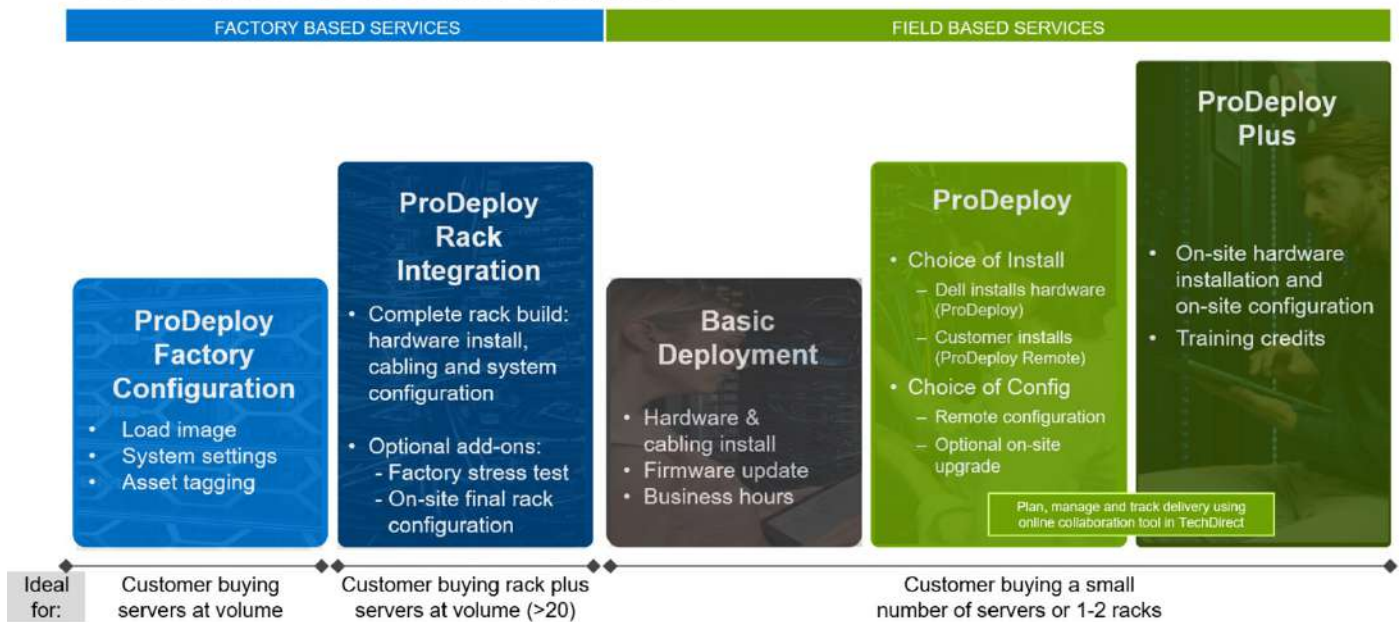

Figure 48. ProDeploy Infrastructure Suite for servers

The new Factory Services consist of two tiers of deployment that happen prior to shipping to the customer's site.

Factory Based Services:

- ProDeploy Factory Configuration - Ideal for customers buying servers in volume and seeking pre-configuration prior to shipping such as: custom image, system settings, and asset tagging so it arrives ready to use out of the box. Furthermore, servers can be packaged and bundled to meet specific shipping and distribution requirements for each customer location to facilitate the rollout process. Upsell one of the field based services (below) if a customer needs assistance with the final server installation.
- ProDeploy Rack Integration - Ideal for customers seeking to build out fully integrated racks prior to shipping. These rack builds include hardware install, cabling, and full system configuration. You can also add-on a factory stress test and optional on-site final rack configuration to complete the rack installation.
 - STANDARD SKUs for Rack Integration is available in US only and requires:
 - 20 or more devices (R and C series servers and all Dell or non-Dell switches). Use Informational SKUs for Dell switches or 3rd party products
 - Shipping to contiguous US
 - USE CUSTOM QUOTE for Rack Integration for:
 - All countries except USA
 - Racks containing less than 20 servers
 - Any rack that includes VxRail or Storage
 - Shipping outside contiguous US
 - Shipping to multiple locations

Field Based Services:

- Basic Deployment consists of the hardware installation, cabling and firmware update during normal standard business hours. Basic Deployment is traditionally sold to Competency Enabled Partners. Competency enabled partners often have Dell do the hardware installation while they complete the software configuration.
- ProDeploy consists of your hardware installation and configuration of the software using offshore resources. ProDeploy is great for customers who are price sensitive or who are remote from their data centers and don't require an onsite presence.
- ProDeploy Plus will give you in-region or onsite resources to complete the engagement for the customer. It also comes with additional features such as Post Deployment Configuration Assistance and Training Credits.

ProDeploy Infrastructure Suite | Factory services

FACTORY BASED SERVICES

		ProDeployFactory Configuration	ProDeploy Rack Integration
Asset configuration	Single point of contact for project management	●	●
	RAID, BIOS and iDRAC configuration	●	●
	Firmware freeze	●	●
	Asset Tagging and Reporting	●	●
	Customer system image	●	●
Factory implementation	Site readiness review and implementation planning	-	●
	Hardware racking and cabling	-	●
	SAM engagement for ProSupport Plus entitled accounts/devices	-	●
	Deployment verification, documentation, and knowledge transfer	●	●
Delivery	White glove logistics	-	●
	Onsite final configuration	-	Onsite add-on
	Install support software and connect with Dell Technologies	-	Onsite add-on
	Basic Deployment	Optional onsite installation	-
Online oversight	Online collaborative environment for planning, managing and tracking delivery	-	●

1 ProDeployRackIntegration Servers are currently only available within the United States.Customer add integration services are still available globally*

DELL Technologies

Figure 49. ProDeploy Infrastructure Suite - Factory services

ProDeploy Infrastructure Suite | Field services

		Basic Deployment	ProDeploy	ProDeploy Plus
Pre-deployment	Single point of contact for project management	●	●	In-region
	Site readiness review	-	●	●
	Implementation planning ¹	-	●	●
	SAM engagement for ProSupport Plus entitled devices	-	-	●
Deployment	Deployment service hours	Business hours	24x7	24x7
	Onsite hardware installation and packaging material removal ² or remote guidance for hardware installation ¹	●	Remote guidance or onsite	Onsite
	Install and configure system software	-	Remote	Onsite
	Install support software and connect with Dell Technologies	-	●	●
	Project documentation with knowledge transfer	-	●	●
Post-deployment	Deployment verification	-	●	●
	Configuration data transfer to Dell Technologies technical support	-	●	●
	30-days of post-deployment configuration assistance	-	-	●
	Training credits for Dell Technologies Education Services	-	-	●
Online oversight	Online collaborative environment in TechDirect for planning, managing and tracking delivery ³	-	●	●

¹ Remote option includes project specific instructions, documentation and live expert guidance for hardware installation. Option available for select hardware. [List is available in the backup portion of this customer presentation](#)

² Packaging removal included with onsite hardware installation

³ Included with ProDeploy or ProDeploy Plus, Not included with Basic Deployment

Figure 50. ProDeploy Infrastructure Suite - Field services

Dell ProDeploy Plus for Infrastructure

From beginning to end, ProDeploy Plus provides the skill and scale that is must successfully perform demanding deployments in today's complex IT environments. Certified Dell experts start with extensive environmental assessments and detailed migration

planning and recommendations. Software installation includes set up of our enterprise connectivity solution (secure connect gateway) and OpenManage system management utilities.

Postdeployment configuration assistance, testing, and product orientation services are also available.

Dell ProDeploy for Infrastructure

ProDeploy provides full-service installation and configuration of both server hardware and system software by certified deployment engineers including set up of leading operating systems and hypervisors as well our enterprise connectivity solution (secure connect gateway) and OpenManage system management utilities. To prepare for the deployment, we conduct a site readiness review and implementation planning exercise. System testing, validation, and full project documentation with knowledge transfer complete the process.

Dell Basic Deployment

Basic Deployment delivers worry-free professional installation by experienced technicians who know Dell servers inside and out.

Additional Deployment Services

You can tailor the ProDeploy Infrastructure Suite offer to meet your customer's unique needs by leveraging "Additional Deployment Time." ADT will cover additional tasks above the normal scope of the standard offers. ADT can be sold for Project Management or Technical Resources and is sold as blocks of four hours remote or eight hours on-site.

Dell ProDeploy for HPC (available in US/Canada only. All other regions use custom)

HPC deployments require specialists that understand that cutting edge is yesterday's news. Dell deploys the world 's fastest systems and understands the nuances that make them perform. ProDeploy for HPC provides:

- Global team of dedicated HPC specialists
- Proven track record, thousands of successful HPC deployments
- Design validation, benchmarking, and product orientation

Learn more at Dell.com/HPC-Services.

ProDeploy Expansion for HPC

*Available as standard SKUs in US & Canada and as custom quote in APJC, EMEA, LATAM

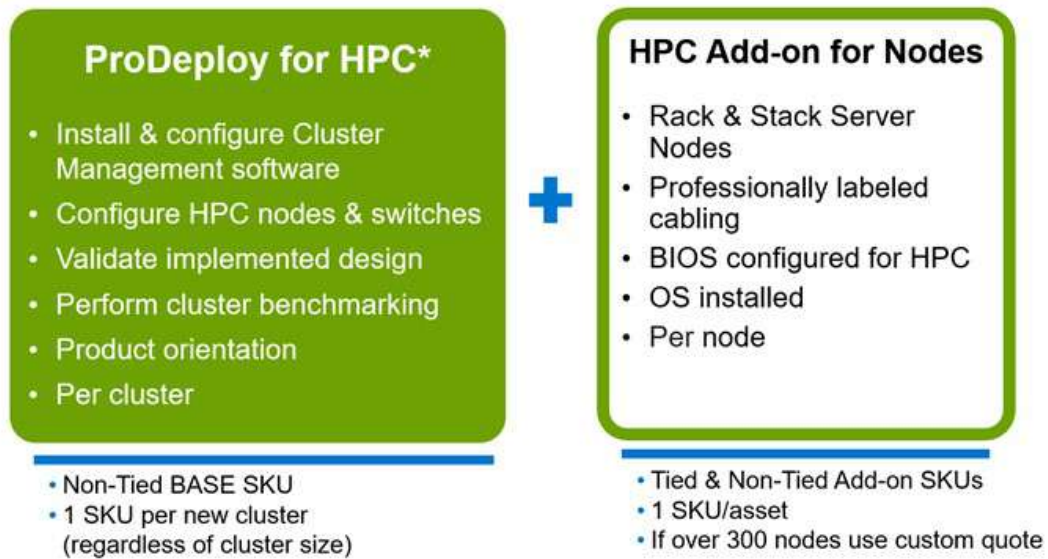

Figure 51. ProDeploy Expansion for HPC

Dell custom deployment Services

Dell custom rack integration and other Dell configuration services help customers save time by providing systems that are racked, cabled, tested, and ready to be integrated into the data center. Dell support preconfigure RAID, BIOS and iDRAC settings, install system images, and even install third-party hardware and software.

For more information, see [Server Configuration Services](#).

Dell Residency Services

Residency Services help customers transition to new capabilities quickly with the assistance of onsite or remote Dell experts whose priorities and time they control.

Residency experts can provide post implementation management and knowledge transfer that is related to a new technology acquisition or day-to-day operational management of the IT infrastructure.

Dell Data Migration Services

Protect business and data of the customer with our single point of contact to manage data migration projects.

A customer project manager works with our experienced team of experts to create a plan using industry-leading tools and proven processes that are based on global best practices to migrate existing files and data, so business systems are up and running quickly and smoothly.

Dell Enterprise Support Services

Dell ProSupport Enterprise Suite

With the ProSupport Enterprise Suite, we help keep IT systems running smoothly, so customers can focus on running their business. We help maintain peak performance and availability of the most essential workloads. ProSupport Enterprise Suite is a suite of support services that enable customers to build the solution that is right for their organization. They choose support models that are based on how they use technology and where they want to allocate resources. From the desktop to the data center, address everyday IT challenges, such as unplanned downtime, mission-critical needs, data and asset protection, support planning, resource allocation, software application management and more. Optimize customer IT resources by choosing the right support model.

Table 26. ProSupport Enterprise Suite

Service	Support model	Description
ProSupport Enterprise Suite	ProSupport Plus for Enterprise	Proactive, predictive, and reactive support for systems that look after your business-critical applications and workloads
	ProSupport for Enterprise	Comprehensive 24 x 7 support
	Basic hardware support	Reactive hardware support during normal business hours

Dell ProSupport Plus for Enterprise

When customers purchase PowerEdge server, we recommend ProSupport Plus, our proactive and preventative support service for business-critical systems. ProSupport Plus provides all the benefits of ProSupport, plus the following:

- An assigned Services Account Manager who knows their business and environment
- Immediate advanced troubleshooting from an engineer
- Personalized, preventive recommendations that are based on analysis of support trends and best practices from across the Dell Technologies infrastructure solutions customer base to reduce support issues and improve performance
- Predictive analysis for issue prevention and optimization that is enabled by secure connect gateway technology
- Proactive monitoring, issue detection, notification, and automated case creation for accelerated issue resolution enabled by secure connect gateway
- On-demand reporting and analytics-based recommendations that are enabled by secure connect gateway and TechDirect

Dell ProSupport for Enterprise

ProSupport service offers highly trained experts around the clock and around the globe to address IT needs. We help minimize disruptions and maximize availability of PowerEdge server workloads with:

- 24x7 support through phone, chat and online
- Predictive, automated tools and innovative technology
- A central point of accountability for all hardware and software issues
- Collaborative third-party support
- Hypervisor, operating system and application support
- Consistent experience regardless of where customers are located or what language they speak

 **NOTE:** Subject to service offer country or region availability.

- Optional onsite parts and labor response options including next business day or four-hour mission critical

ProSupport Enterprise Suite Feature Comparison

	Basic	ProSupport	ProSupport Plus
Remote technical support	9x5	24x7	24x7
Covered products	Hardware	Hardware Software	Hardware Software
Onsite hardware support	Next business day	Next business day or 4hr mission critical	Next business day or 4 hr mission critical
3 rd party collaborative assistance		●	●
Self-service case initiation and management		●	●
Access to software updates		●	●
Proactive storage health monitoring, predictive analytics and anomaly detection with CloudIQ and the CloudIQ mobile app		●	●
Priority access to specialized support experts			●
Predictive detection of hardware failures			●
3 rd party software support			●
An assigned Service Account Manager			●
Proactive, personalized assessments and recommendations			●
Proactive systems maintenance			●

Availability and terms of Dell Technologies Services vary by region and by product. For more information, please view our [service descriptions](#).

© 2022 Dell Technologies

Figure 52. ProSupport Enterprise Suite

Dell ProSupport One for Data Center

ProSupport One for Data Center offers flexible site-wide support for large and distributed data centers with more than 1,000 assets. This offering is built on standard ProSupport components that leverage our global scale but are tailored to a customer's needs. While not for everyone, this service option offers a truly unique solution for Dell Technologies largest customers with the most complex environments.

- Team of assigned Services Account Managers with remote, on-site options
- Assigned ProSupport One technical and field engineers who are trained on the customer's environment and configurations
- On-demand reporting and analytics-based recommendations that are enabled by secure connect gateway and TechDirect
- Flexible on-site support and parts options that fit their operational model
- A tailored support plan and training for their operations staff

Dell ProSupport Add-on for HPC

The ProSupport Add-on for HPC provides solution-aware support including:

- Access to senior HPC experts
- Advanced HPC cluster assistance: performance, interoperability, and configuration
- Enhanced HPC solution level end-to-end support
- Remote presupport engagement with HPC Specialists during ProDeploy implementation

Learn more at Dell.com/HPC-Services.

ProSupport Add-on for HPC is an add-on to PS or PSP

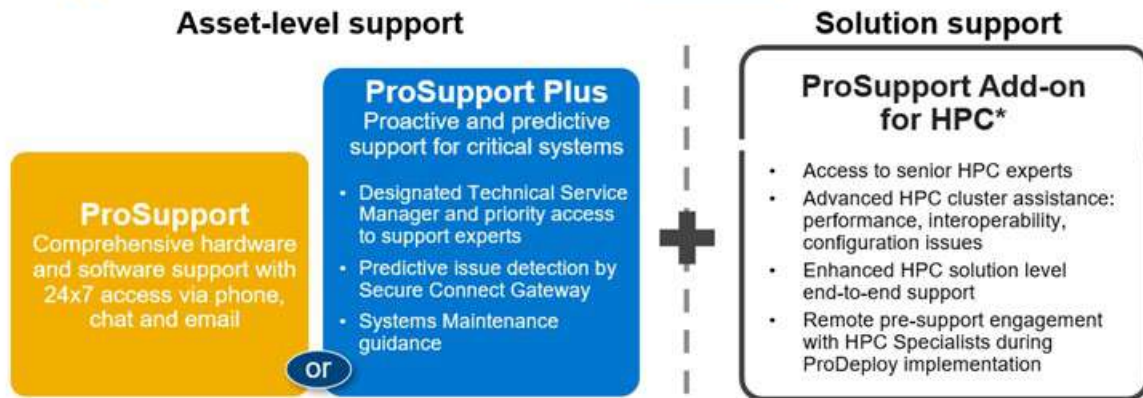

Eligibility

- All server, storage, and networking nodes in cluster must have PS or PSP **AND** PS Add-on for HPC attached
- All HW expansions to clusters must attach PS or PSP **AND** PS Add-on for HPC
- To retrofit an entire existing cluster with PS Add-on for HPC:
 1. HPC Specialists must review and validate the existing cluster
 2. PS or PSP **AND** the PS Add-on for HPC (APOS) must be attached to all server, storage and networking nodes

*Available in standard SKUs in NA and EMEA and as custom quote in APJC & LATAM

DELLTechnologies

Figure 53. ProSupport Add-on for HPC is an add-on to PS or PSP

Support Technologies

Powering the support experience with predictive, data-driven technologies.

NOTE: SupportAssist Enterprise capabilities are now part of the secure connect gateway technology.

Enterprise connectivity

The best time to solve a problem is before it happens. The automated proactive and predictive support features enabled by the secure connect gateway technology helps reduce steps and time to resolution, often detecting issues before they become a crisis. The gateway technology is available in virtual and application editions. It is also implemented as a direct connect version for select Dell hardware and a Services plugin within OpenManage Enterprise for PowerEdge servers. The legacy SupportAssist Enterprise solution has been retired and is now replaced by the secure connect gateway solutions.

Benefits include:

- Value: Our connectivity solutions are available to all customers at no additional charge
- Improve productivity: Replace manual, high-effort routines with automated support
- Accelerate time to resolution: Receive issue alerts, automatic case creation, and proactive contact from Dell experts
- Gain insight and control: Optimize enterprise devices with insights in portals reporting like TechDirect, and get predictive issue detection before the problem starts

NOTE: Connect devices can access these features. Features vary depending on the service level agreement for the connected device. ProSupport Plus customers experience the full set of automated support capabilities.

Table 27. Features enabled by connectivity

	Basic hardware warranty	ProSupport	ProSupport Plus
Automated issue detection and system state information collection	Supported	Supported	Supported
Proactive, automated case creation and notification	Not supported	Supported	Supported

Table 27. Features enabled by connectivity (continued)

	Basic hardware warranty	ProSupport	ProSupport Plus
Predictive issue detection for failure prevention	Not supported	Not supported	Supported

Get started at DellTechnologies.com/secureconnectgateway.

Dell TechDirect

TechDirect helps boost IT team productivity when supporting Dell systems.

Boost your productivity with online service for Dell products from TechDirect. From deployment to technical support, TechDirect lets you do more with less effort and faster resolution. You can:

- Open and manage support requests or in-warranty systems
- Execute online self-service for parts dispatch
- Collaborate on ProDeploy infrastructure deployment projects online
- Manage proactive and predictive alerts from secure connect gateway technology that help maximize uptime
- Integrate services functionality into your help desk with TechDirect APIs
- Join over 10,000 companies that choose TechDirect

Register at TechDirect.Dell.com.

Dell Technologies Consulting Services

Our expert consultants help customers transform faster, and quickly achieve business outcomes for the high value workloads Dell PowerEdge systems can handle. From strategy to full-scale implementation, Dell Technologies Consulting can help determine how to perform IT, workforce, or application transformation. We use prescriptive approaches and proven methodologies that are combined with portfolio and partner ecosystem of Dell Technologies to help achieve real business outcomes. From multi cloud, applications, DevOps, and infrastructure transformations, to business resiliency, data center modernization, analytics, workforce collaboration, and user experiences-we are here to help.

Dell Managed Services

Some customers prefer Dell to manage the complexity and risk of daily IT operations, Dell Managed Services utilizes proactive, AI enabled delivery operations and modern automation to help customers realize desired business outcomes from their infrastructure investments. With these technologies, our experts run, update and fine-tune customer environments aligned with service levels, while providing environment-wide and down-to-the-device visibility. There are two types of managed service offers. First the outsourcing model or CAPEX model where Dell manages the customer owned assets using our people and tools. The second is the as-a-Service model or OPEX model called APEX. In this service, Dell owns all technology and all the management of it. Many customers will have a blend of the two management types depending on the goals of the organization.

Managed	Outsourcing or CAPEX model	APEX	as-a-Service or OPEX model
<p>We manage your technology using our people and tools.¹</p> <ul style="list-style-type: none"> • Managed detection and response* • Technology Infrastructure • End-user (PC/desktop) • Service desk operations • Cloud Managed (Pub/Private) • Office365 or Microsoft Endpoint 		<p>We own all technology so you can off-load all IT decisions.</p> <ul style="list-style-type: none"> • APEX Cloud Services • APEX Flex on Demand elastic capacity • APEX Data Center Utility pay-per-use model 	

1 – Some minimum device counts may apply. Order via: ClientManagedServices.sales@dell.com

* Managed detection and response covers the security monitoring of laptops, servers, & virtual servers. Min. 50 devices combined. No Networking or Storage-only systems [SAN/NAS]. Available in 32 countries. [Details here](#)

Figure 54. Dell Managed Services

Dell Technologies Education Services

Build the IT skills required to influence the transformational outcomes of the business. Enable talent and empower teams with the right skills to lead and perform transformational strategy that drives competitive advantage. Leverage the training and certification required for real transformation.

Dell Technologies Education Services offers PowerEdge server training and certifications that are designed to help customers achieve more from their hardware investment. The curriculum delivers the information and the practical, firsthand skills that their team must confidently install, configure, manage, and troubleshoot Dell servers.

To learn more or register for a class today, see Education.Dell.com.

Appendix A: Additional specifications

Topics:

- Chassis dimension
- Chassis weight
- NIC port specifications
- Video specifications
- USB Ports
- PSU rating
- Environmental specifications

Chassis dimension

The R760 has the following dimensions:

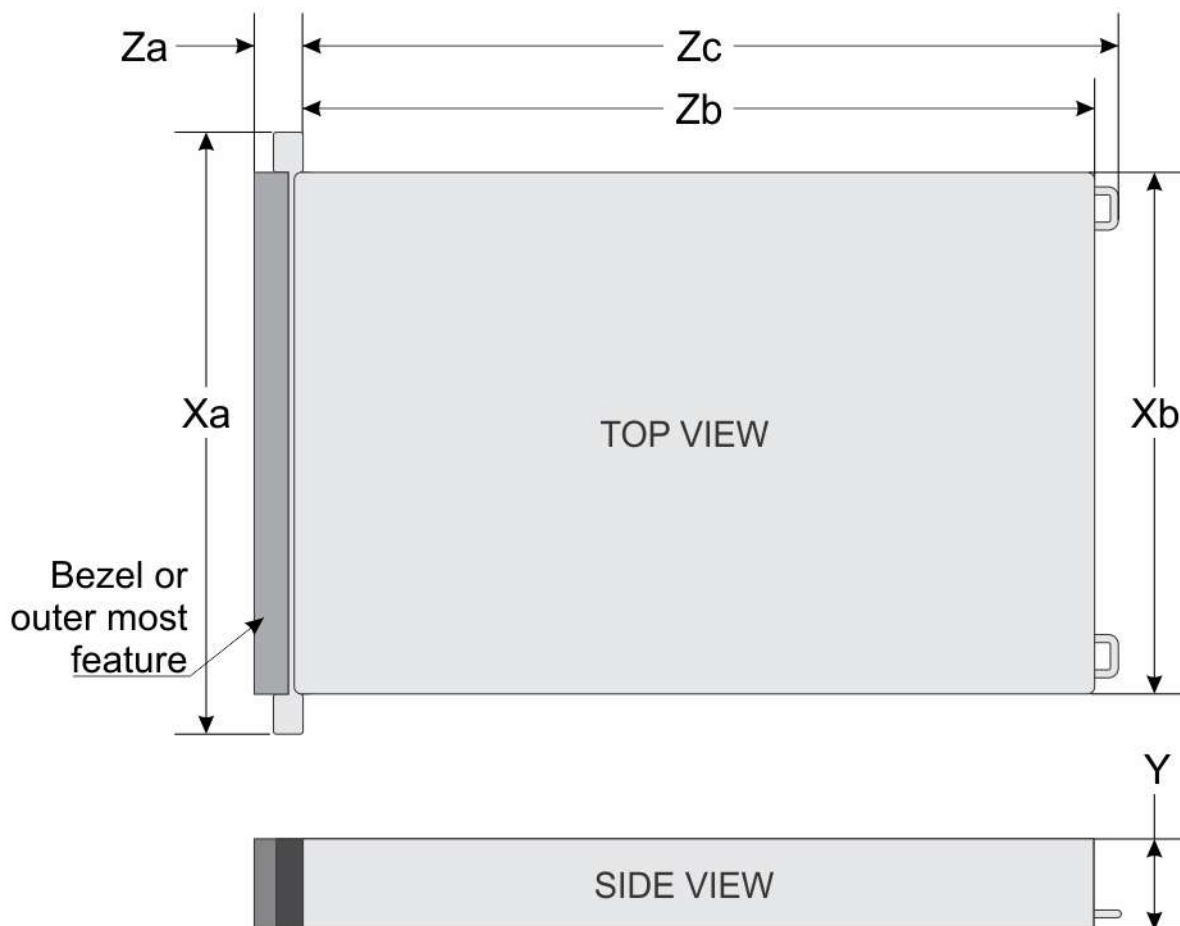

Figure 55. Chassis dimensions

Table 28. Chassis dimensions

Model number	Xa	Xb	Y	Za with bezel	Za without bezel	Zb	Zc	Max Sys Wgt	Chassis
R760	482 mm	434 mm	86.8 mm	35.84 mm	22 mm	700.7 mm	736.29 mm	36.1 kg	2U

Chassis weight

Table 29. Chassis weight

System Configuration	Maximum Weight
A server with fully populated drives	36.1 kg (79.58 lbs)
A server without drives and PSU installed	25.1 kg (55.33 lbs)

NIC port specifications

The PowerEdge R760 system supports up to two Network Interface Controller (NIC) ports embedded on the LAN on Motherboard (LOM) card and up to four ports integrated on the Open Compute Project (OCP) card.

Table 30. NIC port specification for the system

Feature	Specifications
LOM card (optional)	1 GbE x 2
OCP card (OCP 3.0) (optional)	1GbE x 4, 10 GbE x 2, 10 GbE x 4, 25 GbE x 2, 25 GbE x 4

NOTE: The system allows either LOM card or an OCP card or both to be installed in the system.

NOTE: On the system board, the supported OCP PCIe width is x8; when x16 PCIe width is installed, it is downgraded to x8.

Video specifications

The platform supports the following video resolution and refresh rates:

Table 31. Video specifications for R760

Resolution	Refresh Rate	Sestotal Freq.	Pixel Clock	DVO DisplayPort
1024 x 768	60 Hz	48.4 kHz	65.0 MHz	Yes*
1280 x 800	60 Hz	49.7 kHz	83.5 MHz	Yes*
1280 x 1024	60 Hz	64.0 kHz	108.0 MHz	Yes*
1360 x 768	60 Hz	47.71 kHz	85.5 MHz	Yes*
1440 x 900	60 Hz	55.9 kHz	106.5 MHz	Yes*
1600 x 900	60 Hz	55.54 kHz	97.75 MHz	Yes*
1600 x 1200	60 Hz	75.0 kHz	162.0 MHz	Yes*
1680 x 1050	60 Hz	64.7 kHz	119.0 MHz	Yes*
1920 x 1080	60 Hz (RB)	67.158 kHz	173.0 MHz	No
1920 x 1200	60 Hz (RB)	74.556 kHz	193.25 MHz	No

*DVO - DP is for investigation only, dependent on Nuvoton DVO capabilities to support up to 165 MHz.

*(RB) - Reduced Blanking for Digital Displays requiring less blank time. It was introduced for Signal Integrity improvements by reducing Pixel Clock rates for VGA- Analog input devices.

USB Ports



Figure 56. Front USB Port



Figure 57. Rear USB Port

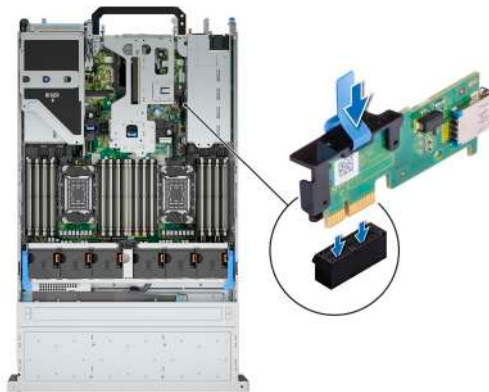

Figure 58. Internal USB Port

Table 32. Systems USB Specifications

Front		Rear		Internal	
USB port type	No. of ports	USB port type	No. of ports	USB port type	No. of ports
USB x.2.0 – compliant port	1	USB x.2.0 – compliant port	1	USB x.3.0 – compliant port	1
		USB x.3.0 – compliant port	1		

PSU rating

Below table lists the power capacity the PSUs in high/low line operation mode.

Table 33. PSUs highline and lowline ratings

—	700 W Titanium	800 W Platinum	1100 W Titanium	1100 W -48 VDC	1400 W Platinum	1800 W Titanium	2400 W Platinum	2800 W Titanium
Peak Power (Highline/-72 VDC)	1190 W	1360 W	1870 W	1870 W	2380 W	3060 W	4080 W	4760 W
Highline/-72 VDC	700 W	800 W	1100 W	1100 W	1400 W	1800 W	2400 W	2800 W
Peak Power (Lowline/-40 VDC)	N/A	1360 W	1785 W	N/A	1785 W	N/A	2380 W	N/A
Lowline/-40 VDC	N/A	800 W	1050 W	N/A	1050 W	N/A	1400 W	N/A
Highline 240 VDC	700 W	800 W	1100 W	N/A	1400 W	1800 W	2400 W	2800 W
DC-48-60 V	N/A	N/A	N/A	1100 W	N/A	N/A	N/A	N/A

The PowerEdge R760 supports up to two AC power supplies with 1+1 redundancy, autosensing, and auto switching capability.

If two PSUs are present during POST, a comparison is made between the wattage capacities of the PSUs. In case the PSU wattages do not match, the larger of the two PSUs is enabled. Also, there is a PSU mismatch warning that is displayed in BIOS, iDRAC, or on the system LCD.

If a second PSU is added at run-time, in order for that particular PSU to be enabled, the wattage capacity of the first PSU must equal the second PSU. Otherwise, the PSU is flagged as unmatched in iDRAC and the second PSU is not enabled.

Dell PSUs have achieved Platinum efficiency levels as shown in the table below.

Table 34. PSU efficiency level

Efficiency Targets by Load						
Form factor	Output	Class	10%	20%	50%	100%
Redundant 60 mm	700 W AC	Titanium	90.00%	94.00%	96.00%	91.50%
	800 W AC	Platinum	89.00%	93.00%	94.00%	91.50%
	1100 W AC	Titanium	90.00%	94.00%	96.00%	91.50%
	1100 W -48 VDC	N/A	85.00%	90.00%	92.00%	90.00%
	1400 W AC	Platinum	89.00%	93.00%	94.00%	91.50%
	1800 W AC	Titanium	90.00%	94.00%	96.00%	94.00%
Redundant 86 mm	2400 W AC	Platinum	89.00%	93.00%	94.00%	91.50%
	2800 W AC	Titanium	90.00%	94.00%	96.00%	94%

Environmental specifications

NOTE: For additional information about environmental certifications, refer to the *Product Environmental Datasheet* located with the *Documentation* on www.dell.com/support/home.

Table 35. Continuous Operation Specifications for ASHRAE A2

Temperature	Specifications
Allowable continuous operations	
Temperature range for altitudes <= 900 m (<= 2953 ft)	10–35°C (50–95°F) with no direct sunlight on the equipment
Humidity percent range (non-condensing at all times)	8% RH with -12°C (10.4°F) minimum dew point to 80% RH with 21°C (69.8°F) maximum dew point
Operational altitude de-rating	Maximum temperature is reduced by 1°C/300 m (1.8°F/984 Ft) above 900 m (2953 Ft)

Table 36. Continuous Operation Specifications for ASHRAE A3

Temperature	Specifications
Allowable continuous operations	
Temperature range for altitudes <= 900 m (<= 2953 ft)	5–40°C (41–104°F) with no direct sunlight on the equipment
	Excursion Limited Operation
	5–35°C (41–95°F) Continuous Operation 35–40°C (95–104°F) 10% Annual Runtime
Humidity percent range (non-condensing at all times)	8% RH with -12°C (10.4°F) minimum dew point to 85% RH with 24°C (75.2°F) maximum dew point
Operational altitude de-rating	Maximum temperature is reduced by 1°C/175 m (1.8°F/574 Ft) above 900 m (2953 Ft)

Table 37. Continuous Operation Specifications for ASHRAE A4

Temperature	Specifications
Allowable continuous operations	
Temperature range for altitudes <= 900 m (<= 2953 ft)	5–45°C (41–113°F) with no direct sunlight on the equipment
	Excursion Limited Operation
	5–35°C (41–95°F) Continuous Operation 35–40°C (95–104°F) 10% Annual Runtime 40–45°C (104–113°F) 1% Annual Runtime
Humidity percent range (non-condensing at all times)	8% RH with -12°C (10.4°F) minimum dew point to 90% RH with 24°C (75.2°F) maximum dew point
Operational altitude de-rating	Maximum temperature is reduced by 1°C/125 m (1.8°F/410 Ft) above 900 m (2953 Ft)

Table 38. Common Environmental Specifications for ASHRAE A2, A3 and A4

Temperature	Specifications
Allowable continuous operations	
Maximum temperature gradient (applies to both operation and non-operation)	20°C in an hour* (36°F in an hour) and 5°C in 15 minutes (9°F in 15 minutes), 5°C in an hour* (9°F in an hour) for tape hardware

Table 38. Common Environmental Specifications for ASHRAE A2, A3 and A4 (continued)

Temperature	Specifications
	<p>i NOTE: * - Per ASHRAE thermal guidelines for tape hardware, these are not instantaneous rates of temperature change.</p>
Non-operational temperature limits	-40 to 65°C (-40 to 149°F)
Non-operational humidity limits	5% to 95% RH with 27°C (80.6°F) maximum dew point
Maximum non-operational altitude	12,000 meters (39,370 feet)
Maximum operational altitude	3,050 meters (10,006 feet)

Table 39. Maximum vibration specifications

Maximum vibration	Specifications
Operating	0.21 G _{rms} at 5 Hz to 500 Hz for 10 minutes (all operation orientations)
Storage	1.88 G _{rms} at 10 Hz to 500 Hz for 15 minutes (all six sides tested)

Table 40. Maximum shock pulse specifications

Maximum shock pulse	Specifications
Operating	Six consecutively executed shock pulses in the positive and negative x, y, and z axis of 6 G for up to 11 ms
Storage	Six consecutively executed shock pulses in the positive and negative x, y, and z axis (one pulse on each side of the system) of 71 G for up to 2 ms

Particulate and gaseous contamination specifications

The following table defines the limitations that help avoid any equipment damage or failure from particulates and gaseous contamination. If the levels of particulates or gaseous pollution exceed the specified limitations and result in equipment damage or failure, you may need to rectify the environmental conditions. Remediation of environmental conditions is the responsibility of the customer.

Table 41. Particulate contamination specifications

Particulate contamination	Specifications
Air filtration	<p>Data center air filtration as defined by ISO Class 8 per ISO 14644-1 with a 95% upper confidence limit</p> <p>i NOTE: This condition applies to data center environments only. Air filtration requirements do not apply to IT equipment designed to be used outside a data center, in environments such as an office or factory floor.</p> <p>i NOTE: Air entering the data center must have MERV11 or MERV13 filtration.</p>
Conductive dust	<p>Air must be free of conductive dust, zinc whiskers, or other conductive particles</p> <p>i NOTE: This condition applies to data center and non-data center environments.</p>
Corrosive dust	<ul style="list-style-type: none"> Air must be free of corrosive dust Residual dust present in the air must have a deliquescent point less than 60% relative humidity <p>i NOTE: This condition applies to data center and non-data center environments.</p>

Table 41. Particulate contamination specifications (continued)

Particulate contamination	Specifications
Walk-Up Edge Data Center or Cabinet (sealed, closed loop environment)	Filtration is not required for cabinets that are anticipated to be opened 6 times or less per year. Class 8 per ISO 1466-1 filtration as defined above is required otherwise <i>i</i> NOTE: In environments commonly above ISA-71 Class G1 or that may have known challenges, special filters may be required.

Table 42. Gaseous contamination specifications

Gaseous contamination	Specifications
Copper coupon corrosion rate	<300 Å/month per Class G1 as defined by ANSI/ISA71.04-2013
Silver coupon corrosion rate	<200 Å/month as defined by ANSI/ISA71.04-2013

Thermal restriction matrix

Table 43. Processor and heat sink matrix

Heat sink	Processor TDP
STD HSK	≤ 165 W (supports only 2.5-inch drives and non-GPU configuration)
2U HPR HSK	125 W–250 W (supports 3.5-inch drives and non-GPU configuration)
	165 W–350 W (supports 2.5-inch drives and non-GPU configuration)
L-type HSK	Supports all GPU/FPGA configurations

i **NOTE:** All GPU/FGPA cards require 1U L-type HSK and GPU shroud.

Table 44. Label reference

Label	Description
STD	Standard
HPR (Silver)	High performance Silver (HPR) fan
HPR (Gold)	High performance Gold (VHP) fan
HSK	Heat sink
LP	Low profile
FH	Full height
DLC	Direct Liquid Cooling

i **NOTE:** The ambient temperature of the configuration is determined by the critical component in that configuration. For example, if the processor's supported ambient temperature is 35°C (95°F), the DIMM is 35°C (95°F), and the GPU is 30°C (86°F), the combined configuration can only support 30°C (86°F).

Table 45. Thermal restriction matrix for air cooled configuration

Configuration		No backplane	8 x 2.5-inch NVMe	16 x 2.5-inch SAS	16 x 2.5-inch NVMe	24 x 2.5-inch SAS			16 x 2.5-inch SAS + 8 x 2.5-inch NVMe	24 x 2.5-inch NVMe	12 x 3.5-inch		Ambient temperature
Rear storage		No rear drives	No rear drives	No rear drives	No rear drives	No rear drives	2 x 2.5-inch with rear fan	4 x 2.5-inch with rear fan	No rear drives	No rear drives	No rear drives	2.5-inch rear drives with rear fan	
CPU TDP/cTDP	T-Case max center (°C)	Fan										HPR GOLD fan 70%^	
125 W	79	STD fan	STD fan	STD fan	STD fan	STD fan	HPR SLVR fan	HPR SLVR fan	STD fan	HPR GOLD fan	HPR SLVR fan	HPR GOLD fan	35°C (95°F)
150 W	72/78 /79	STD fan	STD fan	STD fan	STD fan	STD fan	HPR SLVR fan	HPR SLVR fan	STD fan	HPR GOLD fan	HPR SLVR fan	HPR GOLD fan	35°C (95°F)
165 W	82/84	STD fan	STD fan	STD fan	STD fan	STD fan	HPR SLVR fan	HPR SLVR fan	STD fan	HPR GOLD fan	HPR SLVR fan	HPR GOLD fan	35°C (95°F)
185 W	80/81 /85	STD fan	STD fan	STD fan	STD fan	STD fan	HPR SLVR fan	HPR SLVR fan	HPR SLVR fan	HPR GOLD fan	HPR GOLD fan	HPR GOLD fan	35°C (95°F)
195 W	96	STD fan	STD fan	STD fan	STD fan	STD fan	HPR SLVR fan	HPR SLVR fan	HPR SLVR fan	HPR GOLD fan	HPR GOLD fan	HPR GOLD fan	35°C (95°F)
205 W	76/84 /85	STD fan	STD fan	STD fan	STD fan	STD fan	HPR SLVR fan	HPR SLVR fan	HPR SLVR fan	HPR GOLD fan	HPR GOLD fan	HPR GOLD fan	35°C (95°F)
225 W	79	STD fan	STD fan	STD fan	STD fan	STD fan	HPR SLVR fan	HPR SLVR fan	HPR SLVR fan	HPR GOLD fan	HPR GOLD fan*	HPR GOLD fan*	35°C (95°F)
250 W	76	STD fan	STD fan	STD fan	STD fan	STD fan	HPR SLVR fan	HPR SLVR fan	HPR SLVR fan	HPR GOLD fan	HPR GOLD fan	HPR GOLD fan	35°C (95°F)
270 W	71/75	HPR SLVR fan	HPR SLVR fan	HPR SLVR fan	HPR SLVR fan	HPR SLVR fan	HPR SLVR fan	HPR SLVR fan	HPR SLVR fan	HPR GOLD fan	Required DLC	Required DLC	35°C (95°F)
300 W	75/76 /81	HPR SLVR fan	HPR SLVR fan	HPR SLVR fan	HPR SLVR fan	HPR SLVR fan	HPR SLVR fan	HPR SLVR fan	HPR SLVR fan	HPR GOLD fan	Required DLC	Required DLC	35°C (95°F)
350 W	79	HPR SLVR fan	HPR SLVR fan	HPR SLVR fan	HPR SLVR fan	HPR SLVR fan	HPR SLVR fan	HPR SLVR fan	HPR SLVR fan	HPR GOLD fan*	Required DLC	Required DLC	35°C (95°F)
350 W	57/66	Required DLC	Required DLC	Required DLC	Required DLC	Required DLC	Required DLC	Required DLC	Required DLC	Required DLC	Required DLC	Required DLC	35°C (95°F)

NOTE: ^The fan speed in the 3.5-inch chassis is limited to 70% due to the drive dynamic profile.

NOTE: *Supported ambient temperature is 30°C (86°F).

Table 46. Thermal restriction matrix for memory with air cooled configuration (non-GPU)

Configuration		No backplane	8 x 2.5-inch NVMe	16 x 2.5-inch SAS	16 x 2.5-inch NVMe	24 x 2.5-inch SAS			16 x 2.5-inch SAS + 8 x 2.5-inch NVMe	24 x 2.5-inch NVMe	12 x 3.5-inch	
Rear storage		No rear drives	No rear drives	No rear drives	No rear drives	No rear drives	2 x 2.5-inch with rear fan	4 x 2.5-inch with rear fan	No rear drives	No rear drives	No rear drives	2.5-inch rear drives with rear fan
DIMM Configuration	2DC/Power	STD fan (CPU TDP <= 250 W)					HPR SLVR fan (CPU TDP up to 350 W)		STD fan (CPU TDP <= 165 W)	HPR GOLD fan (CPU TDP up to 350 W)	HPR GOLD fan 70% (CPU TDP up to 250 W)^	
256 GB RDIMM	12.7 W	30°C (86°F)	N/A	N/A	N/A	N/A	35°C (95°F)	35°C (95°F)	N/A	N/A	N/A	N/A
128 GB RDIMM	8.9 W	35°C (95°F)	35°C (95°F)	35°C (95°F)	35°C (95°F)	30°C (86°F)	35°C (95°F)	35°C (95°F)	30°C (86°F)	35°C (95°F)	30°C (86°F)	30°C (86°F)
64 GB RDIMM	6.9 W	35°C (95°F)	35°C (95°F)	35°C (95°F)	35°C (95°F)	35°C (95°F)	35°C (95°F)	35°C (95°F)	35°C (95°F)	35°C (95°F)	30°C (86°F)	30°C (86°F)
32 GB RDIMM	4.1 W	35°C (95°F)	35°C (95°F)	35°C (95°F)	35°C (95°F)	35°C (95°F)	35°C (95°F)	35°C (95°F)	35°C (95°F)	35°C (95°F)	35°C (95°F)	35°C (95°F)
16 GB RDIMM	3 W	35°C (95°F)	35°C (95°F)	35°C (95°F)	35°C (95°F)	35°C (95°F)	35°C (95°F)	35°C (95°F)	35°C (95°F)	35°C (95°F)	35°C (95°F)	35°C (95°F)
DIMM Configuration	2DC/Power	HPR SLVR fan (CPU TDP up to 350 W)								HPR GOLD fan (CPU TDP up to 350 W)	HPR GOLD fan 70% (CPU TDP up to 250 W)	
256 GB RDIMM	12.7 W	30°C (86°F)	Required DLC	Required DLC	Required DLC	35°C (95°F)	35°C (95°F)	35°C (95°F)	35°C (95°F)	Required DLC	30°C (86°F), Required DLC	30°C (86°F), Required DLC
128 GB RDIMM	8.9 W	35°C (95°F)	35°C (95°F)	35°C (95°F)	35°C (95°F)	35°C (95°F)	35°C (95°F)	35°C (95°F)	35°C (95°F)	35°C (95°F)	30°C (86°F)	30°C (86°F)
64 GB RDIMM	6.9 W	35°C (95°F)	35°C (95°F)	35°C (95°F)	35°C (95°F)	35°C (95°F)	35°C (95°F)	35°C (95°F)	35°C (95°F)	35°C (95°F)	30°C (86°F)	30°C (86°F)
32 GB RDIMM	4.1 W	35°C (95°F)	35°C (95°F)	35°C (95°F)	35°C (95°F)	35°C (95°F)	35°C (95°F)	35°C (95°F)	35°C (95°F)	35°C (95°F)	35°C (95°F)	35°C (95°F)
16 GB RDIMM	3 W	35°C (95°F)	35°C (95°F)	35°C (95°F)	35°C (95°F)	35°C (95°F)	35°C (95°F)	35°C (95°F)	35°C (95°F)	35°C (95°F)	35°C (95°F)	35°C (95°F)

NOTE: In 12 x 3.5-inch with rear module configuration, for CPU TDP greater than 270 W and specific Low Temperature-case CPUs are not supported.

NOTE: ^The fan speed in the 3.5-inch chassis is limited to 70% due to the drive dynamic profile.

Table 47. Thermal restriction matrix for rear NVMe drives with air cooled configuration (non-GPU)

Configuration			24 x 2.5-inch SAS		12 x 3.5-inch	
Rear storage			2 x 2.5-inch with rear fan	4 x 2.5-inch with rear fan	2 x 2.5-inch with rear fan	4 x 2.5-inch with rear fan
Drive type	Drives capacity	Power	HPR SLVR fan		HPR GOLD fan 70%	
Kioxia CD7	15.36 TB	19 W	35°C (95°F)	35°C (95°F)	30°C (86°F)	30°C (86°F)
Samsung PM9A3	7.68 TB	14 W	35°C (95°F)	35°C (95°F)	30°C (86°F)	30°C (86°F)
Samsung PM1733	15.36 TB	22 W	30°C (86°F)	30°C (86°F)	30°C (86°F)	30°C (86°F)
Samsung PM1733a	15.36 TB	19.7 W	35°C (95°F)	30°C (86°F)	30°C (86°F)	N/A
Samsung PM1735a	12.8 TB	19.8 W	35°C (95°F)	30°C (86°F)	30°C (86°F)	N/A
Intel P5520	15.36 TB	20 W	35°C (95°F)	35°C (95°F)	35°C (95°F)	35°C (95°F)

Table 48. Thermal restriction matrix for GPU configurations

Configuration		No backplane	8 x 2.5-inch NVMe	8 x 2.5-inch NVMe + 8 x 2.5-inch SAS	16 x 2.5-inch SAS	16 x 2.5-inch NVMe	24 x 2.5-inch SAS	16 x 2.5-inch SAS + 8 x 2.5-inch NVMe	24 x 2.5-inch NVMe
Rear storage		No rear drives	No rear drives	No rear drives	No rear drives	No rear drives	No rear drives	No rear drives	No rear drives
CPU TDP/cTDP	T-Case max center (°C)	HPR GOLD fan with 1U HPR L-Type HSK							
125 W	79	35°C (95°F)	35°C (95°F)	35°C (95°F)	35°C (95°F)	35°C (95°F)	35°C (95°F)	35°C (95°F)	35°C (95°F)
150 W	72/78/79	35°C (95°F)	35°C (95°F)	35°C (95°F)	35°C (95°F)	35°C (95°F)	35°C (95°F)	35°C (95°F)	35°C (95°F)
165 W	82/84	35°C (95°F)	35°C (95°F)	35°C (95°F)	35°C (95°F)	35°C (95°F)	35°C (95°F)	35°C (95°F)	35°C (95°F)
185 W	80/81/85	35°C (95°F)	35°C (95°F)	35°C (95°F)	35°C (95°F)	35°C (95°F)	35°C (95°F)	35°C (95°F)	35°C (95°F)
195 W	96	35°C (95°F)	35°C (95°F)	35°C (95°F)	35°C (95°F)	35°C (95°F)	30°C (86°F)	30°C (86°F)	30°C (86°F)
205 W	76/84/85	35°C (95°F)	35°C (95°F)	35°C (95°F)	35°C (95°F)	35°C (95°F)	35°C (95°F)	35°C (95°F)	35°C (95°F)
225 W	79	35°C (95°F)	35°C (95°F)	35°C (95°F)	35°C (95°F)	35°C (95°F)	35°C (95°F)	35°C (95°F)	35°C (95°F)
250 W	76	35°C (95°F)	35°C (95°F)	35°C (95°F)	35°C (95°F)	35°C (95°F)	35°C (95°F)	35°C (95°F)	35°C (95°F)
270 W	75	35°C (95°F)	35°C (95°F)	35°C (95°F)	35°C (95°F)	35°C (95°F)	35°C (95°F)	35°C (95°F)	35°C (95°F)
270 W	71	35°C (95°F)	35°C (95°F)	35°C (95°F)	35°C (95°F)	35°C (95°F)	30°C (86°F)	30°C (86°F)	30°C (86°F)

Table 48. Thermal restriction matrix for GPU configurations (continued)

Configuration		No backplane	8 x 2.5-inch NVMe	8 x 2.5-inch NVMe + 8 x 2.5-inch SAS	16 x 2.5-inch SAS	16 x 2.5-inch NVMe	24 x 2.5-inch SAS	16 x 2.5-inch SAS + 8 x 2.5-inch NVMe	24 x 2.5-inch NVMe
Rear storage		No rear drives	No rear drives	No rear drives	No rear drives	No rear drives	No rear drives	No rear drives	No rear drives
CPU TDP/cTDP	T-Case max center (°C)	HPR GOLD fan with 1U HPR L-Type HSK							
300 W	75/76/81	35°C (95°F)	35°C (95°F)	35°C (95°F)	35°C (95°F)	35°C (95°F)	35°C (95°F)	30°C (86°F)	30°C (86°F)
350 W	79	30°C (86°F)	30°C (86°F)	30°C (86°F)	30°C (86°F)	30°C (86°F)	30°C (86°F)	Required DLC	Required DLC
350 W	57/66	Required DLC	Required DLC	Required DLC	Required DLC	Required DLC	Required DLC	Required DLC	Required DLC

Table 49. GPU type support thermal restriction for both Air cooling and Liquid cooling configuration

Configuration	8 x 2.5-inch NVMe	16 x 2.5-inch SAS and split NVMe-SAS	16 x 2.5-inch NVMe	24 x 2.5-inch SAS	16 x 2.5-inch SAS + 8 x 2.5-inch NVMe	24 x 2.5-inch NVMe
Rear storage	No rear drives	No rear drives	No rear drives	No rear drives	No rear drives	No rear drives
GPU	HPR GOLD fan with 1U HPR L-Type HSK					
A40 (Max 2)	35°C (95°F)	35°C (95°F)	30°C (86°F)	30°C (86°F)	30°C (86°F)	30°C (86°F)
A100 80 GB (Max 2)	35°C (95°F)	35°C (95°F)	35°C (95°F)	35°C (95°F)	35°C (95°F)	35°C (95°F)
A16 (Max 2)	35°C (95°F)	35°C (95°F)	35°C (95°F)	35°C (95°F)	35°C (95°F)	35°C (95°F)
A30 (Max 2)	35°C (95°F)	35°C (95°F)	35°C (95°F)	35°C (95°F)	35°C (95°F)	35°C (95°F)
A2 (Max 6)	35°C (95°F)	35°C (95°F)	35°C (95°F)	35°C (95°F)	35°C (95°F)	35°C (95°F)
H100 (Max 2)	35°C (95°F)	35°C (95°F)	35°C (95°F)	35°C (95°F)	35°C (95°F)	35°C (95°F)
A800 (Max 2)	35°C (95°F)	35°C (95°F)	35°C (95°F)	35°C (95°F)	35°C (95°F)	35°C (95°F)

Table 50. Thermal restriction matrix for memory with air cooled configuration (GPU)

Configuration		No backplane	8 x 2.5-inch NVMe	16 x 2.5-inch SAS*	16 x 2.5-inch NVMe**	24 x 2.5-inch SAS*	16 x 2.5-inch SAS + 8 x 2.5-inch NVMe***	24 x 2.5-inch NVMe***
DIMM Configuration	2DPC/Power	HPR GOLD fan with 1U HPR L-Type HSK						
256 GB RDIMM	12.7 W	30°C (86°F)	30°C (86°F)	30°C (86°F)	30°C (86°F)	Required DLC	Required DLC	Required DLC
128 GB RDIMM	8.9 W	35°C (95°F)	35°C (95°F)	35°C (95°F)	35°C (95°F)	35°C (95°F)	35°C (95°F)	35°C (95°F)
64 GB RDIMM	6.9 W	35°C (95°F)	35°C (95°F)	35°C (95°F)	35°C (95°F)	35°C (95°F)	35°C (95°F)	35°C (95°F)
32 GB RDIMM	4.1 W	35°C (95°F)	35°C (95°F)	35°C (95°F)	35°C (95°F)	35°C (95°F)	35°C (95°F)	35°C (95°F)

Table 50. Thermal restriction matrix for memory with air cooled configuration (GPU) (continued)

Configuration		No backplane	8 x 2.5-inch NVMe	16 x 2.5-inch SAS*	16 x 2.5-inch NVMe**	24 x 2.5-inch SAS*	16 x 2.5-inch SAS + 8 x 2.5-inch NVMe***	24 x 2.5-inch NVMe***
DIMM Configuration	2DPC/Power	HPR GOLD fan with 1U HPR L-Type HSK						
16 GB RDIMM	3 W	35°C (95°F)	35°C (95°F)	35°C (95°F)	35°C (95°F)	35°C (95°F)	35°C (95°F)	35°C (95°F)

NOTE: *In 16 x 2.5-inch SAS and 8 x 2.5-inch NVMe configurations, for CPU TDP 350 W supported ambient temperature is 30°C (86°F).

NOTE: **In 16 x 2.5-inch NVMe configuration, for CPU TDP greater than 300 W supported ambient temperature is 30°C (86°F).

NOTE: ***In 24 x 2.5-inch SAS/NVMe configuration and 16 x 2.5-inch SAS + 8 x 2.5-inch NVMe, for CPU TDP 270 W - 300 W and specific Low Temperature-case CPUs supported ambient temperature is 30°C (86°F).

Table 51. Thermal restriction for memory with liquid cooled configuration(non-GPU)

Configuration	No backplane	8 x 2.5-inch NVMe	16 x 2.5-inch SAS	16 x 2.5-inch NVMe	24 x 2.5-inch SAS				16 x 2.5-inch SAS + 8 x 2.5-inch NVMe	24 x 2.5-inch NVMe	12 x 3.5-inch^			Ambient temperature
					No rear drives	2 x 2.5-inch with rear fan	4 x 2.5-inch with rear fan	No rear drives			No rear drives	2 x 2.5-inch with rear fan	4 x 2.5-inch with rear fan	
DIMM Configuration	Power	Fan												
256 GB RDIMM	12.7 W	HPR SLVR fan	HPR SLVR fan	HPR SLVR fan	HPR SLVR fan	HPR SLVR fan	HPR SLVR fan	HPR SLVR fan	HPR SLVR fan	HPR SLVR fan	HPR GOLD fan*	HPR GOLD fan*	HPR GOLD fan*	35°C (95°F)
128 GB RDIMM	8.9 W	STD fan	STD fan	STD fan	STD fan	STD fan	STD fan	STD fan	STD fan	STD fan	HPR GOLD fan	HPR GOLD fan	HPR GOLD fan	35°C (95°F)
64 GB RDIMM	6.9 W	STD fan	STD fan	STD fan	STD fan	STD fan	STD fan	STD fan	STD fan	STD fan	HPR GOLD fan	HPR GOLD fan	HPR GOLD fan	35°C (95°F)
32 GB RDIMM	4.1 W	STD fan	STD fan	STD fan	STD fan	STD fan	STD fan	STD fan	STD fan	STD fan	HPR GOLD fan	HPR GOLD fan	HPR GOLD fan	35°C (95°F)
16 GB RDIMM	3 W	STD fan	STD fan	STD fan	STD fan	STD fan	STD fan	STD fan	STD fan	STD fan	HPR GOLD fan	HPR GOLD fan	HPR GOLD fan	35°C (95°F)

NOTE: ^The fan speed in the 3.5-inch chassis is limited to 70% due to the drive dynamic profile.

NOTE: *Supported ambient temperature is 30°C (86°F).

Table 52. Thermal restriction for memory with liquid cooled configuration(GPU)

Configuration		No backplane	8 x 2.5-inch NVMe	16 x 2.5-inch SAS	16 x 2.5-inch NVMe	24 x 2.5-inch SAS			16 x 2.5-inch SAS + 8 x 2.5-inch NVMe	24 x 2.5-inch NVMe	Ambient temperature
Rear storage		No rear drives	No rear drives	No rear drives	No rear drives	No rear drives	2 x 2.5-inch with rear fan	4 x 2.5-inch with rear fan	No rear drives	No rear drives	
DIMM Configuration	Power	Fan									
256 GB RDIMM	12.7 W	HPR GOLD fan									35°C (95°F)
128 GB RDIMM	8.9 W										
64 GB RDIMM	6.9 W										
32 GB RDIMM	4.1 W										
16 GB RDIMM	3 W										

Thermal air restrictions

Table 53. Air cooling configurations thermal restriction for AHSRAE A3 and A4

ASHRAE	A3/40°C (104°F)	A4/45°C (113°F)
PSU	Two PSUs are required in redundant mode. If there is PSU failure, system performance may be reduced.	
PCIe card	Non-Dell qualified peripheral cards and peripheral cards greater than 25 W are not supported.	
GPU/FPGA	Not supported	
DIMM	128 GB, or greater capacity DIMMs are not supported.	
PCIe SSD	Not supported	
Front storage	Not supported in 12 x 3.5-inch SAS configuration.	
Rear storage	Not supported	
Fan	HPR SLVR fans are required.	
Processor	≤ 165 W	≤ 125 W
OCP	Supported with 85°C (185°F) active optic cable.	Supported with 85°C (185°F) active optic cable and cards tier ≤4.
BOSS	BOSS-N1 is supported.	BOS-N1 is not supported.

Table 54. Liquid cooling configurations thermal restriction for AHSRAE A3 and A4

ASHRAE	A3/40°C (104°F)	A4/45°C (113°F)
PSU	Two PSUs are required in redundant mode. If there is PSU failure, system performance may be reduced.	
PCIe card	Non-Dell qualified peripheral cards and peripheral cards greater than 25 W are not supported.	
GPU/FPGA	Not supported	

Table 54. Liquid cooling configurations thermal restriction for AHSRAE A3 and A4 (continued)

ASHRAE	A3/40°C (104°F)	A4/45°C (113°F)
DIMM	128 GB, or greater capacity DIMMs are not supported.	
PCIe SSD	Not supported	
Front storage	Not supported in 12 x 3.5-inch SAS configuration.	
Rear storage	Not supported	
Fan	HPR SLVR fans are required in 2.5-inch configurations systems.	
OCP	Supported with 85°C (185°F) active optic cable.	Supported with 85°C (185°F) active optic cable and cards tier ≤4.
BOSS	BOSS-N1 is supported.	BOSS-N1 is not supported.

Appendix B. Standards compliance

The system conforms to the following industry standards.

Table 55. Industry standard documents

Standard	URL for information and specifications
ACPI Advance Configuration and Power Interface Specification, v2.0c	https://uefi.org/specsandtesttools
Ethernet IEEE 802.3-2005	https://standards.ieee.org/
HDG Hardware Design Guide Version 3.0 for Microsoft Windows Server	microsoft.com/whdc/system/platform/pcdesign/desguide/serverdg.mspx
IPMI Intelligent Platform Management Interface, v2.0	intel.com/design/servers/ipmi
DDR5 Memory DDR5 SDRAM Specification	jedec.org/standards-documents/docs/jesd79-4.pdf
PCI Express PCI Express Base Specification Rev. 2.0 and 3.0	pcisig.com/specifications/pciexpress
PMBus Power System Management Protocol Specification, v1.2	http://pmbus.org/Assets/PDFS/Public/PMBus_Specification_Part_1_Rev_1-1_20070205.pdf
SAS Serial Attached SCSI, v1.1	http://www.t10.org/
SATA Serial ATA Rev. 2.6; SATA II, SATA 1.0a Extensions, Rev. 1.2	sata-io.org
SMBIOS System Management BIOS Reference Specification, v2.7	dmtf.org/standards/smbios
TPM Trusted Platform Module Specification, v1.2 and v2.0	trustedcomputinggroup.org
UEFI Unified Extensible Firmware Interface Specification, v2.1	uefi.org/specifications
USB Universal Serial Bus Specification, Rev. 2.7	usb.org/developers/docs

Appendix C Additional resources

Table 56. Additional resources

Resource	Description of contents	Location
Installation and Service Manual	<p>This manual, available in PDF format, provides the following information:</p> <ul style="list-style-type: none"> • Chassis features • System Setup program • System indicator codes • System BIOS • Remove and replace procedures • Diagnostics • Jumpers and connectors 	Dell.com/Support/Manuals
Getting Started Guide	<p>This guide ships with the system, and is also available in PDF format. This guide provides the following information:</p> <ul style="list-style-type: none"> • Initial setup steps 	Dell.com/Support/Manuals
Rack Installation Guide	<p>This document ships with the rack kits, and provides instructions for installing a server in a rack.</p>	Dell.com/Support/Manuals
System Information Label	<p>The system information label documents the system board layout and system jumper settings. Text is minimized due to space limitations and translation considerations. The label size is standardized across platforms.</p>	Inside the system chassis cover
Quick Resource Locator (QRL)	<p>This code on the chassis can be scanned by a phone application to access additional information and resources for the server, including videos, reference materials, service tag information, and Dell contact information.</p>	Inside the system chassis cover
Enterprise Infrastructure Planning Tool (EIPT)	<p>The Dell online EIPT enables easier and more meaningful estimates to help you determine the most efficient configuration possible. Use EIPT to calculate the power consumption of your hardware, power infrastructure, and storage.</p>	Dell.com/calc